

2023-24 Saskatchewan Driver's Handbook

A guide to safe driving



2023-24 Saskatchewan Driver's Handbook

A guide to safe driving

You can view this handbook online at sgi.sk.ca/handbook. There, you can use the Tools function to have the handbook translated* into a language of your choice.

This handbook is accurate as of September 2023. Please consult the online version at sgi.sk.ca/handbook for the most up-to-date information.

* Google Translate is a third-party tool, and is not owned or administered by SGI. SGI is not responsible for any errors or omissions as a result of the translation. In case of a difference in interpretation between the translated version and the laws and regulations governing Saskatchewan drivers and vehicles, the laws and regulations prevail.

SGI
Take care out there.

Table of contents

1. INTRODUCTION	1
2. SASKATCHEWAN'S DRIVER'S LICENCE PROGRAM	2
2.1 Driver's licence	3
Restrictions and endorsements	4
Fake ID	4
2.2 Vehicle registration	5
How auto insurance works in Saskatchewan	5
Licence plate insurance coverage	5
Your vehicle deductible	7
Coverage for specific single-vehicle losses	7
Coverage for multiple-vehicle losses	7
Personal Auto Injury Insurance	8
Extended Auto Insurance	8
2.3 Graduated Driver Licensing Program	9
What is Graduated Driver Licensing?	9
Steps in the Graduated Driver Licensing program	9
Graduated Driver Licensing Improvement program	11
Appeals	11
2.4 Change of name or address	11
2.5 Classified licence system	12
Licence Class 1 – minimum age: 18	12
Licence Class 2 – minimum age: 18	12
Licence Class 3 – minimum age: 18	13
Licence Class 4 – minimum age: 18	13
Licence Class 5 – minimum age: 16	14
Licence Class 7 – minimum age: 16	15
2.6 Medical requirements	16
2.7 Operating in the United States	16
2.8 Mandatory driver education	16
2.9 Preparing for your road test	17
2.10 Before the examination	17
2.11 Your test	17
Knowledge tests	17
Vision test	18
Learning period	18
Road test	18
3. BASIC INFORMATION AND RULES OF THE ROAD	21
The six basic driving conditions	21
3.1 Speeding, stunting and racing	22
3.2 Distracted driving	23
Cellphones	23
3.3 Stopping and parking	24
3.4 Sharing the road	24
Sharing the road with large trucks	24
Sharing the road with snow plows	26
Sharing the road with snowmobiles, ATVs and golf carts	26
Sharing the road with emergency vehicles	27
Sharing the road with farm equipment and overwidth vehicles	27

	Sharing the road with school buses	27
	Sharing the road with motorcycles	28
	Sharing the road with bicycles	29
	Sharing the road with e-scooters (electric kick scooters)	30
	Sharing the road with tow trucks and vehicles rendering assistance on the roadside	30
	Sharing the road with funeral processions	30
3.5	The concept of gates	31
3.6	Blind spots	32
3.7	Directional dividing lines	33
3.8	Traffic lanes	34
3.9	Lane position	34
3.10	Lane selection	34
3.11	Signalling	35
	Turn signals	35
3.12	Changing lanes	36
3.13	Passing	36
	Passing Lanes	37
3.14	Bus lanes and bicycle lanes	38
3.15	Turning	40
	Right turns	40
	Left turns.	42
3.16	Centre turning lanes	45
3.17	Right of way	46
	Uncontrolled intersections	46
	Controlled intersections	48
	Construction or maintenance vehicles.	49
	Zipper merge	49
3.18	Stopping positions	50
3.19	Interchanges.	51
	Roundabouts	51
	Diverging Diamond Interchange	52
	Restricted Crossing U-Turn	54
3.20	Highways	55
	Driving to the left of centre	55
	One-way highways	55
	Divided highways.	55
	Controlled access highways.	55
3.21	Pedestrians.	55
	Jaywalkers	55
3.22	Crossing urban streets	56
3.23	Wheelchairs and medical scooters	56
3.24	Motorcycles	57
3.25	Medians	57
3.26	Parking lots.	58
3.27	Headlights	59
3.28	Night driving and low visibility.	60
3.29	Choosing the right speed	60
3.30	Rules related to vehicles	61

4. TRAFFIC SIGNS AND SIGNALS	62
4.1 Traffic signs	62
4.2 Six basic sign shapes every driver must know	62
4.3 Standard sign colours	64
4.4 Regulatory signs	64
4.5 Regulatory parking signs	66
4.6 Regulatory pedestrian crossing signs	66
4.7 Regulatory lane designation signs	67
4.8 Regulatory turn control signs	68
4.9 Warning signs	69
4.10 Construction signs	73
4.11 Railway crossings	74
Automatic protected crossings	74
4.12 Crossroad delineators	75
4.13 Guide signs	75
4.14 Information signs	76
4.15 Traffic signals	77
5. BASIC DRIVING SKILLS	80
5.1 Hazards	80
Real and potential hazards	80
5.2 The IPDE method of driving	81
Identify	81
Predict	81
Decide	82
Execute	82
Practice makes perfect	82
5.3 Time – the key to judgment	83
The language of time	84
Using time to estimate your following distance	85
5.4 Eye use	88
Steer where you look	88
Search patterns on highways and rural roads	89
Looking up on highways	89
Referencing down on highways	91
Sweeping highways with your eyes	91
Filling in the gap on highways	91
Checking your gates on highways	91
Checking your instruments on highways	92
Search patterns in urban areas	92
Looking up in urban areas	92
Referencing down in urban areas	92
Sweeping with your eyes in urban areas	93
Filling in the gap in urban areas	93
Checking your gates in urban areas	93
Checking your instruments in urban areas	93
Search patterns at night	93
Search patterns in emergencies	93
Preventing potential collisions	94
Driving in dense traffic	95
5.5 Before you drive	95
Vehicle familiarization	95
Design components for safety	96

	Seating position	99
5.6	Steering	101
	Hand positions	101
	“Hand over hand”	102
	“Hand-to-hand”	102
5.7	Accelerating	103
5.8	Standard (manual) transmission vehicles	103
	Neutral/clutch	103
5.9	Automatic transmission vehicles	104
5.10	Low speed skills	104
	Low speed manoeuvring	104
	Backing	105
	Steering techniques for backing	106
6.	ADVANCED DRIVING SKILLS	107
6.1	Parking	107
	Parallel parking	107
	Back-up cameras	108
	Angle parking	109
	Parking on a hill	110
6.2	Turning	110
	U-turns	110
	Two-point turns	111
6.3	Highway driving	112
	Cruise control	113
	Restricted access freeways	113
	Entering a freeway	113
	While on the freeway	113
	Leaving a freeway	114
	If you miss an exit	114
	Emergencies on the freeway	114
6.4	Passing	115
	Estimation of safe passing time	115
	Estimation of the closing time of two vehicles	116
	The safe/unsafe judgment	116
	The actual passing judgment	117
	Being passed	117
6.5	Curves and corners	118
6.6	Driving in mountains	119
6.7	Grid, municipal and resource access roads	119
	Driving techniques for gravel roads	119
6.8	Winter driving	120
	Preparing your vehicle	120
	Preparing to see and to be seen	121
	Driving on slippery surfaces	121
	How to get moving	123
	How to stop on slippery surfaces	123
	Temptations to resist	123
	Whiteouts	123
	The first snowfalls	123
	Survival	124
6.9	Braking	124
	Threshold braking	125

	Four-wheel lock braking	125
6.10	Emergency driving	126
	Where to look	126
	Emergency braking techniques	126
	Emergency steering techniques	126
	Combined braking and steering	128
	Neutral/declutch	128
	Skidding	128
	Drifting onto a soft shoulder	130
	Ditches	130
	Blow-outs	131
	Brake failure	131
	Power steering or power brake failure	132
	Accelerator sticking	132
	Headlight failure	132
	Animals on the road	132
6.11	Understanding collisions	134
6.12	What to do if you're in a collision	135
	Protect the scene	135
	Check all injuries	135
	Contact the police	135
	Check for witnesses	136
	Take photographs	136
	When to provide a report to police	136
	Dangerous goods	136
	Power lines	136
	Exchange information with other drivers	137
	Report to SGI	137
6.13	Impairing factors (other than drugs and alcohol)	139
	Fatigue	139
	Personal stress and illness	139
	Aggressive driving	140
	Fog, dust, heavy rain and poor visibility	140
	Cellphones	141
	Cigarette smoke	141
7.	DRINKING, DRUGS AND DRIVING	142
7.1	Alcohol	142
	Facts about drinking and driving in Saskatchewan*	142
	The impairing effects of alcohol on the brain	142
	Sequence of effects on the body	142
	How alcohol affects you	143
	Likelihood of a crash	144
	BAC and time	144
7.2	Drugs	145
	Facts about drugs and driving in Saskatchewan*	145
	Prescription, over-the-counter, and recreational drugs	145
	Illegal drugs	147
7.3	Drinking and drugs combined	148
	Students Against Drinking and Driving (SADD)	149

- 8. COMPLYING WITH THE LAW WHEN DRIVING..... 150**
- 8.1 *The Traffic Safety Act* **150**
 - Enforcement..... 150
 - Stopping when signalled by police 150
 - Producing driver’s licence and registration..... 150
 - Unsafe vehicles 150
 - Vehicle impoundments 150
 - Impaired driving 151
- 8.2 The Criminal Code of Canada 154
 - Impaired Driving Offences 154
 - Other Criminal Code driving offences..... 156
 - Arrest 156
 - Licence disqualifications..... 156
 - Reinstatement of driving privileges 157
 - Special restricted driver’s licence 158
- 8.3 Traffic tickets 158
- 8.4 Driver Improvement Program 159
- 8.5 Safe Driver Recognition 160
 - Safety Rating Scale..... 160
 - How it works 161
 - Fuel-efficient driving techniques..... 163

- INDEX 166**

1. Introduction

Thanks for picking up the Saskatchewan Driver's Handbook!

Driver training is a rite of passage many of us share. Now that the time has come to get your driver's licence, SGI wants to help you get ready. We created this handbook to teach you the basics, like:

- traffic signs and signals
- the rules of the road
- driving in different weather conditions, like snow, rain and fog
- sharing the road with other vehicles, pedestrians and bicyclists

The handbook also covers advanced skills, like how to predict what other drivers might do, and then how to respond in the moment.

A handy resource for new and experienced drivers alike, study this book before your test and keep consulting it even after you get your licence. It can help you pass your driver's test and lay the groundwork for decades of safe driving.

If we could offer one piece of advice, it's to get as much practice as you can with your supervising driver. The confidence gained from hands-on experience behind the wheel will help you when it's time for your road test.

Good luck on your path to becoming a great driver.

We'll see you on the road!

2. Saskatchewan's driver's licence program

Driver programs and examinations are designed to develop safe and capable drivers who know and understand the rules of the road. Driving is a responsibility and a privilege. It's not a right. Provincial regulations exist to meet safety needs as well as promote the efficient and safe flow of traffic.

To drive in Saskatchewan you must hold a valid driver's licence for the type of vehicle you wish to operate. The classified driver's licence system establishes minimum standards of skill, knowledge, physical and mental fitness for the safe operation of different types of vehicles. Drivers are then licensed accordingly.

The first time you apply for a Saskatchewan driver's licence, you'll be asked to provide documents to prove your identity, proof of residency and entitlement to be in Canada. Each document must be from an authority such as a federal or provincial government or a federal agency (a full list of approved documents can be found in SGI's *Establishing Your Identity* pamphlet). They must also be originals, not photocopies. Electronic scans of these documents may be kept on file, in keeping with Canadian standards.

To get a driver's licence, you must be able to operate a vehicle safely and properly, understand all traffic signs and know the rules of the road. You're required to complete a driver's examination if you:

- Have never been a licensed driver;
- Have not held a Saskatchewan driver's licence or specific Class or Endorsement within the past five years;
- Wish to become a certified driver instructor in Saskatchewan;
- Want to change the class of your licence or obtain an endorsement; or
- Are a new resident, and the licence you hold is from another province, state or country not honoured or recognized in Saskatchewan. Licences may be honoured from the United States. Licences from Germany, Switzerland, South Korea, the United Kingdom, Republic of Ireland, Isle of Man, Australia, Austria, Belgium, France, Japan, Jersey, Netherlands, New Zealand, Ukraine and Taiwan may be exchanged for a Saskatchewan Class 5 driver's licence and motorcycle endorsement, where applicable. Saskatchewan may also accept a driver's licence from a country not listed. Please check with any Saskatchewan motor licence issuer, driver examination office, or visit www.sgi.sk.ca/newresidents or contact us toll free at 1-844-TLK-2SGI (1-844-855-2744). The nine-month learning period and driver training requirement may be waived if you can prove past driving experience by providing a valid driver's licence, written in English or French, or a valid licence in another language accompanied by a translation document acceptable to SGI (i.e. International Driving Permit).

If you're a new resident wanting a Saskatchewan driver's licence without being tested, you must meet some requirements:

- If you're a former resident of a Canadian province or territory you must have a valid driver's licence from that jurisdiction. An expired driver's licence (not older than five years) from that jurisdiction is also acceptable. New residents may drive with their valid out-of-province driver's licence for 90 days after moving to Saskatchewan.

2.1 Driver's licence

Note: Once a Saskatchewan driver's licence of any class is validated, the driver's licence from any home jurisdiction becomes invalid.

- If you're a former resident of one of the countries we honour, as listed on the previous page, a valid licence and a copy of your driving record from that jurisdiction must be provided, accompanied by a translation document acceptable to SGI (i.e. International Driving Permit).

2.1 Driver's licence

Your driver's licence expires on the last day of your birth month or the last day of the month that your immigration documents expire.

Saskatchewan driver's licenses offer enhanced security features and meet international standards, integrating facial recognition technology.

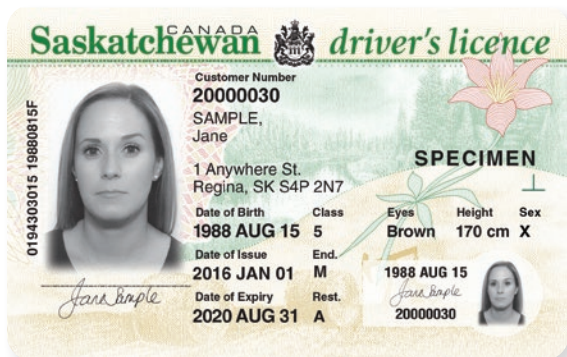

The driver's licence shown here was implemented on April 1, 2016.

You must show your licence if a peace officer asks to see it. If you don't have your licence with you at the time, the officer may allow you up to 48 hours to produce it. If your licence includes any restrictions, you must obey the restrictions when driving. See the next page for restriction codes.

If you're a visitor or temporary foreign worker, your existing licence gives you all of the same privileges it does in your home province, territory or state, excluding Class 1 vehicles (semis). If you want to drive a semi, you will need to take Mandatory Entry-Level Training and get a Saskatchewan Class 1 driver's licence. As a visitor to Saskatchewan, you aren't eligible to apply for a Saskatchewan driver's licence. As a visitor, you don't have to register your vehicle in this province unless you become a resident.

Full-time students attending approved educational institutions, as well as their immediate families, don't have to exchange their driver's licence during the time they are living here to attend classes. Your existing licence gives you all of the same privileges it does in your home province, territory or state, excluding Class 1 vehicles (semis). If you become a Saskatchewan resident you may drive using your current driver's licence and vehicle plates for 90 days after taking up residence.

Restrictions and endorsements

Restriction code	
A	– must wear prescribed glasses or contact lenses
B	– may not drive at night
C	– may only drive within a 40 kilometre radius of address shown on licence
D	– may only drive within a 80 kilometre radius of address shown on licence
E	– may only drive outside the limits of a city, in a city as a learner
F	– must have two outside rear-view mirrors on vehicle
G	– driver must present Detail Authority Card
H	– motorcycles are limited to three-wheeled cycles, two-wheeled as a learner
J	– motorcycles are limited to cycles under 50 cc's, larger as a learner
K	– school bus capacity is limited to under 36 passengers
L	– may not operate Class 2 or 4 vehicles
M	– Class 1-3 vehicles are limited to automatic/electronic shift transmission, standard transmission as a learner
N	– may only drive school bus with automatic transmission
R	– motorcycles are limited to 400cc's and under
T	– may not transport passengers for hire
W	– restricted commercial class (Canada only)

Endorsement code	
A	– may operate vehicle with air brakes
G	– driver must present Detail Authority Card
M	– motorcycle
S	– school bus
1, 2, 3 or 4	– may operate that class of vehicle as a learner
6	– may drive motorcycle as a learner

All driving authority is subject to medical approval.

Fake ID

Do the right thing and only use your own legal driver's licence or photo ID card. It's a criminal offence to alter a photo ID card or the driver's licence paper certificate in any way. It may not seem like a big deal, but there are serious consequences to using fraudulent ID, or loaning your ID for fraudulent purposes, including:

- getting your real driver's licence suspended for at least three months
- a fine of at least \$125
- a possible fraud conviction under the Criminal Code that could affect your employment, your education and chances of travelling outside of Canada
- getting other people fined, fired or put out of business

2.2 Vehicle registration

All vehicles must be properly registered according to purpose and must display the appropriate licence plate.

Licence plates must be securely attached and clearly visible. That means plates must not be obstructed in a way that prevents them from being read or accurately photographed by any enforcement system.



The number or identity of the licence plate must not be altered or changed in any way.

If you're a new resident you have up to 90 days to register your vehicle in Saskatchewan. Basic insurance coverage is required. A non-resident (someone who does not own, rent or lease a residence in Saskatchewan and, if required, does not pay Saskatchewan income tax) may drive in Saskatchewan indefinitely providing your out-of-province or out-of-country driver's licence remains valid.

How auto insurance works in Saskatchewan

Saskatchewan auto insurance comes in two parts:

Basic minimum coverage – Is required by law and is purchased at the same time you pay for your licence plates and vehicle registration. This coverage is compulsory and is provided by SGI.

Additional coverage – Sometimes referred to as extended auto insurance, a package policy or an Auto Pak, additional coverage is tailored to your needs and is provided on a separate auto insurance policy. This important protection may be purchased from the insurance company, broker or agent of your choice.

Licence plate insurance coverage

Your licence plate carries basic insurance coverage in three areas:

Collision and comprehensive – Coverage for damage to your vehicle, subject to a deductible.

Personal injury – Benefits for personal injury resulting from a vehicle collision.

Liability – Insurance for damage your vehicle causes to another vehicle or property, or injury to others.

Collision and comprehensive is also known as physical damage coverage. It pays for damage to your vehicle due to a collision or other occurrence such as hail, fire or theft.*

* Most vehicles are covered to the actual cash value, which is the market value of your vehicle compared with similar vehicles, with similar equipment, mileage and condition to the insured vehicle (see Coverage limitations referenced in the *Driver's Licence and Basic Auto Insurance* brochure).

Personal injury benefits provide Saskatchewan residents with injury and death benefits if they are injured or killed in an automobile collision anywhere in Canada or the United States. All Saskatchewan residents have a choice between two equally priced auto injury coverages – No Fault Coverage and Tort Coverage.

Liability coverage protects you as a vehicle owner and driver if you and/or your vehicle are responsible for injuries caused to others or damage to property belonging to others. 'Others' may be another motorist, a pedestrian or bicyclist, a passenger in your vehicle, or the owner of property you damage.

To be liable is to be at fault and responsible for damage or injury. You can be liable whether you choose No Fault or Tort injury (all Saskatchewan residents are automatically covered with No Fault injury coverage unless they choose Tort injury coverage and file a declaration form). Liability coverage will pay the cost to defend you if someone claims you are liable, as well as the damages if you are found responsible.

Plate insurance provides up to \$200,000 in liability coverage. Although compensation for many injuries and damages is covered under the collision and comprehensive coverage or the personal injury benefits, there are also many situations where compensation will be based on who is at fault, what happened and where it happened (for instance, if you were driving in the U.S. or another Canadian province). These include damage to buildings or fences near a street, to cargo in a vehicle you collide with, or to trains, cargo, and tracks at a level crossing, including environmental damage. If you're responsible for an injury or death in Saskatchewan of someone whose earnings were greater than the personal injury benefit amount, or to anyone out of province, you will likely have a liability claim.

No Fault Coverage

Saskatchewan residents with No Fault Coverage receive a comprehensive package of benefits regardless of the circumstances of the collision. Benefits include coverage for income loss, medical and rehabilitation expenses, permanent impairment and death benefits. Those with No Fault Coverage can sue for certain expenses not covered by their benefits, as well as for income loss which exceeds the benefits provided by the plan. Except in very limited circumstances, they cannot sue for pain and suffering.

Tort Coverage

Saskatchewan residents with Tort Coverage receive a basic package of benefits regardless of the circumstances of the collision. Benefits include some coverage for income loss, medical and rehabilitation expenses, permanent impairment and death benefits. Those with Tort Coverage who are not totally at fault for the collision can sue for expenses and income losses not covered by their benefits and for pain and suffering, subject to a \$5,000 deductible.

For more information on No Fault Coverage, Tort Coverage or how to choose your auto injury insurance, visit www.sgi.sk.ca or ask any SGI office or SGI motor licence issuing office for informational materials that explain the coverages.

Your vehicle deductible

Your plate insurance covers loss of, or damage to, your vehicle and its equipment from causes such as a collision, upset, fire, theft, windstorm or hail. Subject to your deductible.

A deductible is applicable to any vehicle loss you may have. It's the amount you are required to pay before your licence plate insurance benefits begin to cover the remaining costs.

For example, if your deductible is \$700 and you're responsible for a collision which causes \$2,000 worth of damage to your vehicle, then SGI will pay for damage in excess of your deductible. You'll be responsible for the first \$700, while SGI will pay the remaining \$1,300.

However, if it's determined that another Saskatchewan driver/owner is responsible for the damage and that person can be identified, that person's insurance will pay for your damage, including your deductible and any other reasonable out-of-pocket expenses.

Coverage for specific single-vehicle losses

Single-vehicle collision – Your damages are covered for the amount in excess of your deductible. You may be able to recover your deductible when there is a responsible party to pursue. Your adjuster will assist you with this. In most single-vehicle collisions the driver is responsible and must pay their own deductible.

Storm or weather-related damage – Even though you're not at fault for weather-related damage, such as hail damage or a tree falling on your vehicle, the deductible applies as there is no responsible party to pursue.

Collision with an animal – If you carry only the compulsory plate insurance, the deductible applies. If you carry additional auto insurance the deductible may be waived for a collision with an animal.

Hit and run – Your damages are covered for the amount in excess of your deductible. You may be able to recover your deductible if the responsible party is identified. Your adjuster will assist you with this.

Theft or vandalism – If you carry only the compulsory plate insurance, the deductible applies. If the responsible party is identified, you may be able to recover your deductible. If you carry additional auto insurance the deductible may be waived for theft of the entire vehicle.

Coverage for multiple-vehicle losses

You're not at fault for the collision – You don't pay the deductible in most cases. The party found at fault for the collision is responsible for your damage, including your deductible. Once your adjuster has confirmed your coverage, you may have your vehicle repaired at the autobody shop of your choice.

You're at fault for the collision – As the at-fault driver you're responsible for your full deductible. Your licence plate insurance will also pay the other driver's deductible and cover any damage to their vehicle.

Shared responsibility for the collision – When two motorists are each found partially responsible for a collision, both drivers pay a portion of their deductible if their vehicle is damaged. For example, if you're found 25% responsible for a collision you pay 25% of your deductible.

Personal Auto Injury Insurance

The Personal Auto Injury Insurance program provides coverage for Saskatchewan residents injured in automobile collisions anywhere in Canada or the United States. Coverage provided depends on which of two auto injury products you choose – No Fault Coverage or Tort Coverage.

Extended Auto Insurance

Basic plate insurance allows you to drive with minimal coverage, but to protect yourself, your family, your passengers, and your vehicle, you may find you'll need more than just the basics. A licensed insurance broker or agent will explain your options and provide advice on economical ways to obtain the protection you need.

Extended auto insurance can cover your vehicle for replacement cost, pay for the cost of a rental if your vehicle is damaged, reduce the deductible you pay for damage to your vehicle and top-up your injury coverage. Most importantly, it increases your liability from the minimum \$200,000.

Despite your efforts to be a good driver, a moment of distraction, tiredness, inexperience, poor road conditions and many other things can result in major collisions. You can be sued and held responsible for damages if you're at fault — even if you have No Fault injury coverage. If you don't have enough insurance or the means to pay for your defence or the damages caused, you may be expected to pay a portion of your earnings for many years as a result of lacking enough coverage.

Recent collision examples

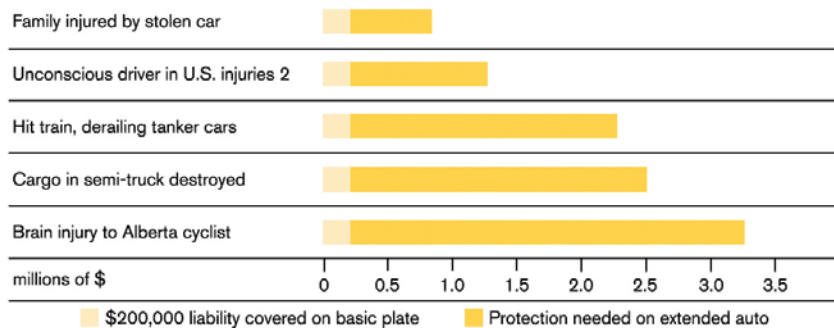

2.3 Graduated Driver Licensing Program

What is Graduated Driver Licensing?

Graduated Driver Licensing (GDL) is a program designed to improve road safety by exposing new drivers to incremental levels of risk as they gain more driving experience. New drivers, regardless of age, are provided with the support, skills and experience they need as they work towards becoming fully qualified drivers.

There are three stages to Saskatchewan's Graduated Driver Licensing program – Learner, Novice 1 and Novice 2. As drivers pass through these stages, they will see fewer restrictions at each stage until they graduate to an experienced Class 5 driver's licence. The Learner, Novice 1 or Novice 2 driving status is indicated on the driver's licence.

Steps in the Graduated Driver Licensing program

1. Obtain a Learner's licence.
2. Practise driving for nine months with a supervising driver.
3. Complete the required mandatory driver training education.
4. Pass a road test.
5. Practise driving as a Class 5 Novice 1 driver for six months.
6. Drive as a Class 5 Novice 2 driver for 12 months with no incidents (e.g., at-fault collision, traffic conviction* and suspension free).

In the event of an incident, the Novice 2 driver will be required to restart the 12-month incident-free period again from the loss date/conviction date. Interruptions such as licence suspensions, refusal to issue or non-renewal will extend the 12 months for any period of time the driver did not hold a valid licence.

7. Graduate to an experienced Class 5 driver's licence.

* Where found to be at fault for a collision or convicted of a traffic offence the 12-month period will restart from the loss date or conviction date respectively.

Graduated Driver Licensing program

	Class 7 – Learner 9 months	Class 5 – Novice 1 6 months	Class 5 – Novice 2 12 months
Requirements	16 years of age (15 years of age in high school program)	16 years of age	
	Pass written test	Pass Class 5 road test	
	Nine months – excludes interruptions (non-renewal, refusal, licence suspension)	Six months – excludes interruptions (non-renewal, refusal, licence suspension)	12 months – excludes interruptions (non-renewal, refusal, licence suspension); and 12 months – at-fault collision, traffic conviction and licence suspension free
	Mandatory education – high school training (30 hours in-class, six hours in-car) or commercial training (six hours in-class, six hours in-car)		
Restrictions	Must have a supervising driver in the front passenger seat at all hours	One passenger only who is not an immediate family member; and	
	Supervising driver must be an experienced, licensed driver		
	Between the hours of midnight and 5 a.m., passengers (excluding the supervising driver) must be immediate family members*	Other passengers must be immediate family members*	
	Number of passengers limited to the number of seatbelts	Number of passengers limited to the number of seatbelts	Number of passengers limited to the number of seatbelts
	Cannot consume any amount of alcohol or drugs and drive (0 BAC)	Cannot consume any amount of alcohol or drugs and drive (0 BAC)	Cannot consume any amount of alcohol or drugs and drive (0 BAC)
	Cannot be a supervising driver	Cannot be a supervising driver	Cannot be a supervising driver
	Cannot obtain a commercial driver's licence or school bus endorsement	Cannot obtain a commercial driver's licence or school bus endorsement	Cannot obtain a commercial driver's licence or school bus endorsement

YOU HAVE GRADUATED TO AN EXPERIENCED LICENCE!

* Immediate family members are defined as spouse, child, parent, sibling, grandparent, step-parent, step-grandparent, stepsibling, foster parent, foster child, foster sibling, parent-in-law, sibling-in-law or child-in-law.

Note: That all drivers in the Graduated Driver Licensing program are prohibited from: 1. Operating both hand held and hands-free electronic communication equipment, such as cellphones, while driving.
2. Operating right-hand drive vehicles.

Graduated Driver Licensing Improvement program

Drivers in any stage who are found at fault for a collision, or who receive convictions or suspensions, will be placed in the Graduated Driver Licensing Improvement program. Drivers will progress through the following steps:

- A warning letter will be sent to the driver if the first traffic incident (conviction) has an assigned rating of two points or fewer.*
- If the first traffic incident (conviction, at-fault collision, suspension) has an assigned rating of three to six points, the driver will be required to attend a Traffic Safety Education session.

Each incident thereafter will result in the driver being required to attend further education courses followed by the administrative suspensions:

- Defensive Driving course
- Driver Improvement training – educates drivers on the responsibilities and consequences associated with driving and encourages safe driving habits
- 30-day driver's licence suspension
- 90-day driver's licence suspension
- 180-day driver's licence suspension
- interview and further action

* For a complete list of offence and driver points, call 1-844-TLK-2SGI (1-844-855-2744).

Appeals

Drivers can appeal all sanctions, with the exception of the warning letter, Traffic Safety Education session, interview request and manual review to the Highway Traffic Board. The board is independent from SGI and has the authority to uphold, alter the decision, issue a restricted licence and reduce or increase the length of any driver's licence suspension.

2.4 Change of name or address

If you change your name and/or address, you must tell SGI within 15 days by writing to us, or at your motor licence issuer's office. Any changes to name and/or date of birth must be also accompanied by a legal document supporting the change.

You can revise your contact information and change your mailing address, physical address or email address through MySGI at www.mysgi.ca.

You can also notify SGI of your change of address through the ExpressAddress online service at www.expressaddress.com. This service can also notify several other provincial and municipal government organizations of your address change at the same time.

2.5 Classified licence system

Licence Class 1 – minimum age: 18

Permits the licence holder to operate

- Class 1 vehicles – power units and semi trailers, and trucks which have a trailer(s) or vehicle(s) in tow where the gross weight of the towed unit(s) exceeds 4,600 kg
- Motor vehicles in classes 2, 3, 4 and 5



Does not permit the licence holder to operate

- Vehicles with air brakes, motorcycles or school buses without an appropriate endorsement(s)

Requirements

Minimum age	18 years and not a novice driver
Medically fit	See page 16
Vision test	See page 18
Knowledge tests	Class 1 knowledge tests include: Class 1, 2, 3, 4, Basic and Sign
Training	Approved Class 1 training program
Trip inspection	Must demonstrate a trip inspection on a Class 1 vehicle
Road test	Must take a road test in a Class 1 vehicle

Licence Class 2 – minimum age: 18

Permits the licence holder to operate

- Class 2 vehicles – buses having a seating capacity in excess of 24 passengers, while carrying a passenger or passengers
- Motor vehicles in classes 3, 4 and 5
- Class 1 vehicles as a learner with appropriate endorsement



Does not permit the licence holder to operate

- Vehicles with air brakes, motorcycles or school buses without an appropriate endorsement(s)

Requirements

Minimum age	18 years and not a novice driver
Medically fit	See page 16
Vision test	See page 18
Knowledge tests	Class 2 knowledge tests include: Class 2, 3, 4, Basic and Sign
Trip inspection	Must demonstrate a trip inspection on a Class 2 vehicle
Road test	Must take a road test in a Class 2 vehicle

Note: For further clarification about the classified licence system, contact your local driver examiner.

1 – Persons with Class 3 or 5 vehicles (registered farm only) with air brakes are not required to have the air brake endorsement

2.5 Classified licence system

Licence Class 3 – minimum age: 18**Permits the licence holder to operate**

- Class 3 vehicles – trucks with more than two axles, except trucks registered in Class F, and trucks with more than two axles which have a trailer(s) or vehicle(s) in tow, except trucks registered in Class F, where the gross weight of the towed unit(s) does not exceed 4,600 kg
- Motor vehicles in classes 4 and 5
- Power units with more than two axles, when not towing a semi trailer
- Class 1 or 2 vehicles as a learner with appropriate endorsement

**Does not permit the licence holder to operate**

- Vehicles with air brakes¹, motorcycles or school buses without an appropriate endorsement(s)

Requirements

Minimum age	18 years and not a novice driver
Medically fit	See page 16
Vision test	See page 18
Knowledge tests	Class 3 knowledge tests include: Class 3, Class 4, Basic and Sign
Trip inspection	Must demonstrate a trip inspection on a Class 3 vehicle
Road test	Must take a road test in a Class 3 vehicle

Licence Class 4 – minimum age: 18**Permits the licence holder to operate**

- Class 4 vehicles – buses that have a seating capacity of not more than 24 passengers, when transporting passengers
- vehicles registered in Class PT when transporting not more than 24 passengers for hire
- vehicles registered in Class PB or PC
 - when transporting not more than 24 passengers for hire; and
 - when not used exclusively to transport passengers with a disability and any attendants to those passengers
- ambulances when being used for hire
- motor vehicles in Class 5. To operate a taxi, limosine or ride share vehicle, the driver must be authorized by SGI.

**Does not permit the licence holder to operate**

- Vehicles with air brakes, motorcycles or school buses without an appropriate endorsement(s)

Requirements

Minimum age	18 years and not a novice driver
Medically fit	See page 16
Vision test	See page 18
Knowledge tests	Class 4 knowledge tests include: Class 4, Basic and Sign
Trip inspection	Must demonstrate a trip inspection on a Class 4 vehicle
Road test	Must take a road test in a Class 4 or 5 vehicle

Licence Class 5 – minimum age: 16

Permits the licence holder to operate

- Class 5 vehicles – cars, vans², two-axle trucks, two-axle vehicles having a trailer(s) or vehicle(s) in tow where the gross weight of the towed unit(s) does not exceed 4,600 kg, buses when not transporting passengers, three-axle motorhomes, taxis and ambulances when not used for hire
- A taxi, limousine or vehicle as part of a vehicle-for-hire service, or Class PB* vehicle if the driver:
 1. is an experienced driver, not in the Graduated Driver Licensing (GDL) program;
 2. has at least two years post-GDL driving experience; and
 3. has a satisfactory driver history (meaning less than 12 points under the Driver Improvement Program in the last two years, and no impaired-driving related suspension in the last 10 years).
- School buses with a capacity of no more than 15 passengers when carrying passengers
- Law enforcement vehicles when being used for law enforcement purposes
- Two-axle power units, when not towing a semi trailer
- Two-axle farm trucks towing vehicles which have a gross weight that exceeds 4,600 kg
- Farm trucks with more than two axles
- Vehicles registered in Class PB or PC when used exclusively to transport, for hire, not more than 24 passengers with a disability and any attendants to these passengers
- Class 1, 2, 3 or 4 vehicles as a learner with appropriate Endorsement 1, 2, 3 or 4 (minimum age 18 and not a novice driver)
- Three-wheeled vehicles (e.g., has a steering wheel, automotive seating and floor controls - not a three-wheeled motorcycle)

*with seating capacity of 10 or less

Does not permit the licence holder to operate

- Vehicles with air brakes³, motorcycles without an appropriate endorsement(s)

Requirements

Vision test	See page 18
Knowledge tests	Class 5 knowledge tests include: Basic and Sign
Road test	Must hold a Class 7 licence for nine months Must take a road test in a Class 5 vehicle
Training	Approved Class 5 training course

Licence Class 5 and 7:

Note: Persons under age 18 require parental consent to obtain driving privileges. Once consent has been granted it cannot be withdrawn.

- 2 – Vans with a seating capacity of 15 or less while carrying passengers. If transporting more than 12 passengers, the driver must be at least 18 years of age and not a novice driver
- 3 – Persons with Class 3 or 5 vehicles (registered farm only) with air brakes are not required to have the air brake endorsement

2.5 Classified licence system

Licence Class 7 – minimum age: 16**15 with High School Driver Education****Permits the licence holder to operate**

- Class 5 vehicles as a learner

Note: Does not permit the licence holder to obtain a motorcycle endorsement or operate three-wheeled vehicles as a learner.

**Requirements****Identification**

You're required to show your full name and date of birth by a birth certificate, passport or immigration documents. You need to provide a signature from a Saskatchewan Health card, passport or a driver's licence from a Canadian jurisdiction or any document acceptable to SGI. Any first-time driver between the ages of 15 and 18 is required to provide a completed Parent/Guardian signature form/Guarantor form available from SGI Driver Development, motor licence issuers or SGI certified driver educators. If your name has changed due to marriage or for other reasons, please bring documentation to support the name change. Be sure to take several pieces of original identification with you (photocopies are not acceptable).

Vision test

See page 18

Knowledge tests

Class 7 knowledge tests include: Basic and Sign

The holder of a Class 7 licence must be supervised. The driving supervisor must:

- at all times, be capable of assuming operation of the vehicle;
- hold the equivalent of a Class 5 or greater driver's licence issued by a Canadian or U.S. jurisdiction;
- have held a valid licence for a minimum of 365 days in the preceding three years (but is not a novice driver); and
- occupy the seat nearest to the driver and the vehicle controls.

Note: The holder of a Class 1 to 5 driver's licence is permitted to operate a snowmobile or ATV. All snowmobile operators born after Jan. 1, 1989, must have taken an approved safety course in addition to holding a Class 1 to 5 driver's licence. The holder of a Class 7 driver's licence is permitted to operate an ATV or snowmobile provided they are accompanied by someone who holds a Class 1 to 5 driver's licence or supervised (within 5 m of and in view of) by someone on another machine that holds a Class 1 to 5 driver's licence.

The holder of a Class 7 or greater licence is permitted to operate a golf cart on a public roadway if the municipality has passed an SGI-approved bylaw permitting its use.

For more information regarding snowmobiles, ATVs and golf carts call SGI's Customer Service Centre at 1-844-TLK-2SGI (1-844-855-2744).

2.6 Medical requirements

When you apply for, or renew, your driver's licence, any medical condition that may affect your ability to drive must be reported to SGI. Write this information on a supplementary medical application, available from all licence issuers. Failure to report medical conditions could result in a loss of insurance coverage. For more information contact SGI's Customer Service Centre at 1-844-TLK-2SGI (1-844-855-2744).

Individuals applying for a Class 1, 2, 3 or 4 driver's licence, or a Class 5 licence with a 1, 2, 3, 4, Heavy Trailer or School Bus Endorsement are required to meet medical standards and file a medical report with SGI before testing begins.

2.7 Operating in the United States

The United States and Canada have a reciprocity agreement, which recognizes a Canadian-issued commercial driver's licence as proof of medical fitness. However, in the United States, the operator of a Class 5 vehicle must have a commercial medical, if the vehicle or vehicle combination weighs or has a rated capacity (Gross Vehicle Weight Rating) over 4,536 kg.

The United States commercial medical requirements also apply to farm-use vehicles registered in Class F, but do not apply to private-use vehicles (e.g., when vacationing in the United States towing a recreational vehicle).

For more information please refer to the *Saskatchewan Professional Driver's Handbook*.

2.8 Mandatory driver education

If you have a Class 7 licence you're not eligible for a higher class of driver's licence unless you've completed the High School Driver Education Program or received a minimum of six hours of in-car and six hours of in-class instruction from an SGI-certified driving instructor. Be sure to attend the parent information night sponsored by your high school educator. When hiring a driving instructor, ask to see their instructor certification card to ensure it's valid. You can find a list of certified driving instructors at www.sgi.sk.ca/onlineservices.

The driver instructor will either add your training record to your electronic SGI customer file or issue a Driver Education Certificate. If there isn't a training record on your SGI customer file, you must present the Driver Education Certificate to the driver examiner at the time of your Class 5 road test(s).

If you're enrolled in the High School Driver Education Program, you'll need to set up a free MySGI account to write your exam online. Any SGI motor licence issuer can set you up with an account. You'll need to present your ID to complete this transaction.

If you're 15 years of age and registered in a certified High School Driver Education Program but have been placed on a waiting list, you're still eligible to write the class 7 licence exam. In order to write the exam you must present a copy of the Signature/Guarantor Form confirming you are enrolled or intend to be enrolled in a driver education program. The Signature/Guarantor Form is available either at your high school or on the SGI website at sgi.sk.ca/new-drivers.

2.9 Preparing for your road test

Get plenty of practice under a variety of driving conditions. Be sure to practise exactly the way your instructor taught you. Keep a record of your practice using the Practice Log available from your driver educator or SGI. Learner driver signs and *A Guide for Supervisors of New Drivers – Co-Pilot's Manual* booklet are available free of charge from SGI.

Road tests are conducted in English. Examiners use simple and clear language when providing directions. To prepare for the road test, drivers should be familiar with the following terms — right turn, left turn, lane change, parallel park, traffic lights, intersection, stop, shoulder check and two-point turn.

2.10 Before the examination

Once you feel confident enough to take a driver examination, you can book your appointment. Call or visit a motor licence issuer or book online with MySGI for Class 5 road tests, motorcycle road tests and all written appointments. If you provide your cellphone number while booking, you'll get text messages to confirm your appointment, along with reminders before your appointment (24 hours and one hour before). You can also check-in by text when you arrive for your road test. For all other driver examination appointments call 1-844-TLK-2SGI (1-844-855-2744). If you don't cancel your appointment and fail to show up, you'll be required to pay for your re-scheduled appointment.

Office hours are 8 a.m. to 5 p.m., Monday to Friday, and 8 a.m. to 5 p.m. on Saturday in Regina and Saskatoon. Written tests are available in Regina and Saskatoon without an appointment and are conducted from 8 a.m. to 4 p.m., Monday to Saturday. Tests are not available on Saturdays of long weekends.

You're required to show proof of age by a birth certificate, passport or any document acceptable to SGI. If you're a first-time driver between the ages of 15 and 18, you must provide a completed *Signature/Guarantor Form For First Time Drivers* providing consent that you may obtain driving privileges. Be sure to take several pieces of **original identification** with you. Photocopies of these documents are not acceptable. If your name has changed due to marriage or other reasons, please bring documentation that supports the name change.

2.11 Your test

For all classes of licence you are required to pass three types of tests including knowledge tests, a vision test and a road test. Some classes of licence also require a medical examination and pre-trip inspection.

Knowledge tests

The knowledge tests consist of two parts: driving situations, as well as the rules of the road, and sign identification. If you fail any part of these tests, you'll be required to rewrite only the examination(s) you failed. **Successful written exam results are valid for one year. You may write only once per day.** If you're unsure about the meaning of any of the questions, please ask the examiner to assist you. The use of cellphones or electronic devices is not allowed in the test area.

You can find practice test questions as well as helpful animations in the online version of this handbook at www.sgi.sk.ca/quiz.

Vision test

The vision test may include:

- a field of vision test
- a visual acuity test
- distance judgment



There are certain minimum vision standards you must meet. If you fail to meet those standards, you may be referred to an ophthalmologist or optometrist for further testing, and possible prescription of glasses or contact lenses. If you can pass the eye test only when you are wearing your glasses or contact lenses, you will be issued a restricted licence. **This means your driver's licence will be valid only when you are wearing prescribed corrective lenses.**

Learning period

The holder of a Class 7 licence must retain that classification for at least nine months before becoming eligible for any examinations toward obtaining a licence in any other class.

Road test

You're required to take a road test in the appropriate class of vehicle and **you must supply the vehicle.**

You must schedule your appointment at your nearest examination office. Road test appointments in smaller centres are reserved for local residents only.

Depending on your location, your examiner may use a paper and a clipboard or a digital app on a tablet to score your driving during the road test.

The road test is an evaluation of your ability to safely operate a vehicle. You'll be tested on:

- abiding by road signs along the route
- anticipation of potential hazards
- parallel parking and backing up
- proper lane driving
- shoulder checking
- starting
- stopping
- traffic signs and signals
- travelling through controlled and uncontrolled intersections
- turning
- various safe driving practices like speed selection and steering techniques

2.11 Your test

When you arrive to your road test, please:

- park and turn off your vehicle;
- stay in your vehicle and text "Here" if you signed up for text notifications;
- make sure your cellphone and ringer/vibrate are on; and
- have your photo ID ready.

Your examiner will call you at your appointment time to ask some questions and then will come out to meet you. To keep everyone safe, your supervising driver should wait in our waiting room, rather than in our high-traffic parking lot, while you take your road test.

If you have any questions about the test, the examiner will be happy to answer them for you before the test starts.

Note: No pets or passengers, other than examination staff, are permitted in your vehicle during the road test.

A road test will be rescheduled if:

- you cannot provide proof of having completed the required driver education (training record on your electronic SGI file or Driver Education Certificate)
- you're late for your appointment
- you don't have the appropriate driver's licence or have not paid the exam fee
- you haven't held a Class 7 licence for at least nine months
- you don't meet the vision or medical fitness standards
- you drive to the test office illegally
- the vehicle you provide for the road test is unsafe or not equipped in accordance with the law. The Driver Examiner will inspect the vehicle before the test begins. The following list of equipment must be in working order, or the test can be rescheduled:
 - horn
 - signal lights
 - brake lights
 - headlights (as required)
 - windshield wipers (as required)
 - working defrost (as required)
 - seatbelts and airbags
 - speedometer
 - one valid licence plate properly attached to the rear of the vehicle
 - unobstructed windshield
 - no aftermarket tinting on the windshield or front side windows
 - functioning driver's and front passenger's doors
 - proper seats
 - the passenger compartment of the vehicle is not clean or free of strong scent or odour
 - the vehicle is not the right class for the licence you want

If your windshield is cracked and you're unsure if it will be accepted for a road test, it's best to have a driver examiner check it before your road test. Visit your local driver examination office to have an examiner look at it in person. You can also visit sgi.sk.ca/windshield to find examples of an acceptable windshield.

You will fail the road test if you:

- exceed the speed limit
- are involved in a collision for which you are 50% or more responsible
- fail to stop where required
- fail to yield to vehicles and pedestrians
- fail to wear a seatbelt
- cannot parallel park
- disobey traffic lights
- fail to follow a request from the examiner
- require the assistance of the examiner
- make a combination of minor mistakes

At the end of the road test, a complete report will be given to you with all errors explained. If you were unsuccessful, the report will indicate where improvement is required. Depending on how the examiner scored your test, you'll either get a paper copy of your results or have them emailed to you. The emailed results include links to the online Driver's Handbook so you can follow up on the areas you need to work on. When you have had more practice, you may make an appointment for another road test. You must pay an additional test fee before each road test.

If you're applying for a Class 5 licence and fail your road test, you must wait two weeks before you are eligible for another road test. Additional training may be recommended or a longer learning period imposed. Successful exam results are valid for 12 months but your licence must be upgraded at any SGI motor licence issuer before you can drive alone.

3. Basic information and rules of the road

The six basic driving conditions

Driver condition

Driver condition refers to your physical, mental and emotional fitness to drive. It's the most important of the six conditions, because a driver in top physical, mental and emotional shape can adjust to all the other conditions and to the errors of other drivers as well.

Vehicle condition

Vehicle condition affects your ability to control your vehicle, your ability to see and be seen, and to communicate with other drivers and pedestrians. Your chances of staying out of a collision are better with a vehicle in tip-top condition than they are with one that has operational defects. You are the only one who knows when something isn't working right. Only you can spot possible vehicle defects and either repair them or get them corrected by a qualified mechanic.

Light condition

The first requirement of safe driving is to see and be seen. This ability is affected by light condition. The presence of natural or artificial light; you can have too little light, or too much light. The hazard of too little light is found in the fact that the nighttime fatal collision rate is more than double the daytime rate.

Weather condition

Bad weather can affect traction, visibility and vehicle control. Rain, snow and ice make road surfaces slippery. Adverse weather can obscure your vision with rain, snow, fog or road splatter, as well, steam up glass with interior vapour. Other drivers find it harder to see you, and pedestrians hide behind umbrellas so they fail to see cars approaching. High winds make steering difficult and cause vehicles to veer to the wrong side of the road.

Road condition

Road condition refers to the total roadway and the type and condition of the road surface. These can affect your ability to steer, stop and manoeuvre. Adverse road conditions can be produced by weather. Conditions change from one kind of road to another – from a side street to a thoroughfare, from a secondary road to a main highway, from a two-lane road to an expressway. Any trip may involve a number of different road conditions, each requiring an adjustment in your driving.

Traffic condition

Traffic conditions are created by the number of vehicles and pedestrians using the same road or street at the same time you are, and to a large extent by how well the road has been engineered to accommodate the amount of traffic present at a given time. More cars mean more conflict in traffic and more chance for a collision. Traffic conditions are influenced by the time of day, day of the week, even time of year in the case of holiday periods, and by the nature of the environment, such as a shopping centre, sports arena, factory or school.

3.1 Speeding, stunting and racing

There are speed limits on all Saskatchewan roads, streets and highways. Always drive your vehicle within the posted speed limit. Emergency vehicles responding to an emergency may exceed the speed limit.

On most provincial highways, and in urban areas, speed limit signs are posted. In the absence of signs, the speed limit is 80 km/h. Most urban centres post speed limit signs at the entrances to the town or city. Those speed limits apply to all locations within community boundaries, unless otherwise posted. The speed limit means the fastest you can travel under ideal conditions.

Stunting and racing can have serious and often life-threatening consequences.

Some of the things that could land you a ticket are:

- racing side by side with another vehicle while disobeying the speed limit
- chasing another vehicle
- speeding in and out of lanes to unsafely pass vehicles
- attempting to lift some or all tires from the roadway (including driving a motorcycle on one wheel)
- attempting to spin a vehicle to cause it to spin or circle
- driving a vehicle while not sitting in the driver's seat
- driving your vehicle in a way that prevents another vehicle from passing
- stopping or slowing down to interfere with the movement of another vehicle

The maximum speed limit when passing tow trucks or emergency vehicles that are stopped with their lights flashing or when passing Ministry of Highways and Infrastructure equipment with lights flashing, whether in motion or not, is 60 km/h. Within the work zone (road maintenance areas), motorists are required to slow down and travel no faster than the posted speed. Fines for speeding triple when passing highway workers or equipment occupied by a worker in the work zone. Some cities have bylaws requiring drivers to obey work zone speed limits through the entire construction area. Please be familiar with the bylaws in your area.

Drivers are also required to reduce their speed to 60 km/h when passing a tow truck stopped on the roadside with its amber or amber and blue lights flashing while it's assisting to a disabled vehicle.

In school zones drivers must be particularly careful. Each city or town sets speed limits in school zones through local bylaws. As a result, laws vary from place to place so watch for signs. If there are no signs, you should still reduce your speed and proceed cautiously in school zones.

3.2 Distracted driving

Police use photo radar to enforce speed limits in some work zones, school zones and high-risk locations. Photo radar tickets are issued to the registered owner of the speeding vehicle driven through the zone.

You must slow down when approaching animals on or near the road.

Regardless of the posted or basic speed limit you must never travel faster than conditions allow for safe and reasonable passage. At the same time, travelling too slowly can be hazardous. You should never drive at a speed slow enough to impede or block other traffic, unless proper safety precautions have been taken.

3.2 Distracted driving

Always drive with care, attention and reasonable consideration for other road users. It's illegal for you, or any of your passengers, to perform stunts or other activities that distract, startle or interfere with other road users.

Driver inattention and distraction is responsible for 14% of all collisions. On average, it leads to 19 fatalities a year in Saskatchewan (based on an average from 2019 – 2021).

Driving requires you to do more than two things at once – steering, braking, shifting gears and watching for traffic all occur at the same time. When you add distractions like eating, grooming, talking or texting on cellphones, the results can be disastrous. Drivers should devote their full attention to driving. Some of the most common driver distractions include persons, objects or events outside the vehicle, distraction from passengers, looking for or at something in the vehicle, adjusting radio, climate or vehicle controls, smoking and eating or drinking.

You also shouldn't distract other road users - deliberately creating loud and unnecessary noise with a motor vehicle is not permitted.

Cellphones

Holding, viewing or manipulating a hand-held cellphone or mobile device is prohibited in Saskatchewan. Experienced drivers, who are no longer in the GDL, can use hands-free cellphones if they're activated with voice commands or one-touch, and are dashboard, visor or cradle mounted.

Note: Hands-free cellphone or mobile devices are prohibited for drivers in the GDL program.

Hands-free use of cellphones while driving is allowed for experienced drivers*, including:

- devices that clip to the visor
- headsets, either wired or wireless
- voice-activated devices
- devices built into the vehicle, such as OnStar or those with Bluetooth technology
- Bluetooth ear pieces
- one-touch activation of a speakerphone feature on a cellphone placed within easy reach

- making 9-1-1 calls on cellphones while driving for both new and experienced drivers
- making a call on a cellphone when parked on the side of the road, for both new and experienced drivers

* Experienced drivers are drivers who are not in the GDL program.

If you have a previous conviction (within a 12-month period) for using electronic communication devices while driving, or driving without reasonable care or consideration, and receive another ticket for either of these offences, it will result in the vehicle you're driving to be impounded for seven days, regardless of who the vehicle owner is.

3.3 Stopping and parking

You must move as far to the right as possible when stopping on a road.

When stopping on a rural road or highway you must be 30 m (98 ft.) away from any vehicle stopped on the opposite side of the road or highway.

Vehicles stopped on rural roads or highways at night must be marked with flares, hazard lights or reflectors. You must not tamper with the devices used to mark stopped vehicles.

Always come to a complete stop at all stop signs and at railway crossings where signals or gates are activated. After stopping, only proceed from a stop sign, or a railway crossing without gates, when it's safe to do so. You must also stop when signaled to by a police officer or a flagperson.

If there are painted curbs or signs that prohibit parking please follow them and park somewhere else.

Be considerate of others and your own safety. If you must stop in your lane (possibly due to heavy traffic) always stop behind the crosswalk, before entering an intersection or before a railway crossing so you don't obstruct pedestrians or other traffic.

3.4 Sharing the road

You have to share the road with people who drive a variety of vehicles. The more you know about the particular driving requirements of different vehicles, the better equipped you'll be to share the road and predict the actions of other drivers.

Sharing the road with large trucks

The large truck is a special vehicle. Its motor is not much larger than a large car engine and yet the load it carries can be 50 or more times the weight of a car. When accelerating up to speed, truck drivers use up to 18 gear changes. Once they get into top gear, they do not appreciate having to start again. Therefore, avoid forcing a truck driver to slow down.



3.4 Sharing the road

Large trucks will decrease speed when going uphill. You can expect truck drivers to pick up speed when going down hills to help them get up the other side. Plan your passing manoeuvre accordingly.

It takes longer to stop a large truck than a car, so a truck driver needs a longer following distance to be safe and in control. Don't cut in front of a large truck immediately after you have passed it.

Truck drivers have problems seeing smaller vehicles. Although they have mirrors that help them to see each side, you may not be visible to the driver if you follow too closely. (Besides, you can't see anything yourself.) Realize that in poor weather, exterior mirrors become spotted with rain and dirt and the truck driver doesn't have an interior mirror. Be sure to make yourself visible. Drive with your headlights on.

The driver of a large truck or bus has difficulty turning sharp corners, particularly to the right. If the driver follows the proper procedure, vehicles facing them on the street they are entering should be prepared for the large truck or bus to enter their half of the roadway. If the large truck operator is not following the proper procedure, vehicles on their right in the street they are leaving should stay well back to avoid being crushed between the large truck and the curb. When you see a large truck or bus making a sharp right turn, give it the room it needs.

All drivers should avoid a large truck's "no-zone." The no-zone refers to the blindspot areas around big trucks, where crashes are most likely to occur. Just like cars, large trucks have blindspots on both sides, but a large truck's are considerably bigger. These blindspots can mean trouble if a trucker decides to change lanes and a car is in the blindspot. In addition to the blindspots on the sides of a large truck, drivers should be careful around the front end of large trucks.

Truckers sit up high and the hood of the cab obscures part of the road ahead. This is why when drivers in a car are passing a large truck, they should make sure they can see the entire truck cab in their rear-view mirror before pulling in front. If a car cuts in too soon, truck drivers are forced to react with little time or room to spare. Large trucks also have deep rear blindspots. A good rule of thumb is that if you can't see the large truck's mirrors, the truck driver can't see you.

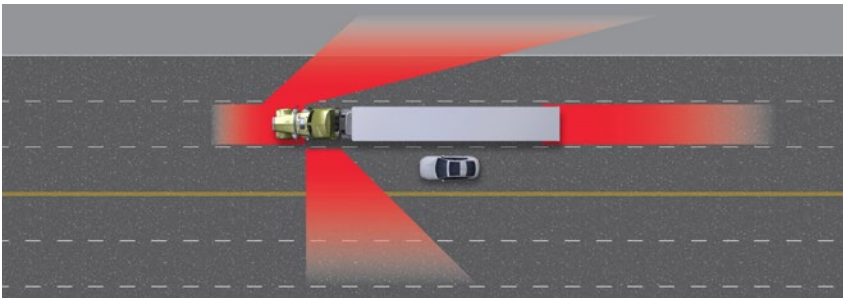

Sharing the road with snow plows

- Slow down – **STAY BACK** and **STAY ALIVE** when you approach the mini blizzard created by a snow plow.
- Every winter, snow plows are hit by motorists who don't see them or see them too late. The vast majority of these incidents are rear-end collisions where motorists have failed to adjust to changing road and weather conditions.
- Snow plow operators are working in difficult weather conditions on the highways to clear snow and ice and make the roads safer for all motorists.
- Drivers must slow to 60 km/h when passing snow plows or other highway equipment that are stopped on the highway with blue and amber warning lights flashing.
- Snow plows that are in motion, can be passed on the highway if it's safe to do so. Drivers in this case are not limited to travelling 60 km/h.
- Snow plows must travel slower than average traffic when clearing snow and spreading salt and sand. Be patient and proceed with caution.
- Ministry of Highways crews clear major highways within six hours of the end of the storm to make winter driving safe. Please give them room to work safely.



Sharing the road with snowmobiles, ATVs and golf carts

If snowmobiles and ATVs were always operated according to the law, there would be little chance of conflict with other vehicles on the streets and highways. Unfortunately, this isn't always the case.

Snowmobiles are difficult to see because they are small and low. These features, accompanied by exposure to weather, also make it difficult for the snowmobile operator to see. As snowmobiles are useful in storms, they're likely to be out when visibility is poor.

Also, children with little road experience operate snowmobiles and ATVs. When you see a snowmobile or ATV, anticipate that it may cross the road suddenly or go out of control, and decide how you will react.

In some municipalities, local bylaws allow snowmobiles, ATVs and golf carts to be operated on the street.



Sharing the road with emergency vehicles

All emergency vehicles (fire engines, police vehicles and ambulances) have the right of way when displaying flashing lights and using sirens (sound devices).

- When approached by an emergency vehicle with its lights flashing or sirens engaged, you must immediately drive as closely as possible to the **right** edge of the roadway and not enter the next intersection until the emergency vehicle has passed. The only exception is if a peace officer gives you other directions. On one-way streets, pull right or left to the nearest curb.
- At an intersection, you must stop and let the emergency vehicle through the intersection, unless given other directions by a peace officer.



If the emergency vehicle has its lights flashing, but no siren engaged, motorists in the vicinity should extend the same privilege as previously mentioned while meeting or being overtaken by the emergency vehicle.

- When an emergency vehicle is stopped on the highway with its emergency lights in operation, you must slow down to 60 km/h when passing it. This doesn't apply to vehicles travelling in the opposite direction on a divided highway. However, this does apply when travelling in the opposite direction on an undivided highway.
- Never attempt to follow an emergency vehicle going to, or coming from, an emergency.

Sharing the road with farm equipment and overwidth vehicles

Saskatchewan's agricultural base means that farm equipment such as combines, tractors, large cultivators, etc. may be on highways and grid roads from early spring until late fall.

These vehicles create a hazard, as they travel very slowly – 10 to 40 km/h. Therefore, you may come upon them very quickly and you'll need to stop or change lanes rapidly. Watch for them on the road and only pass them when it's safe to do so.



Sharing the road with school buses

School bus drivers have a difficult job. There are plenty of distractions inside the bus. Knowing this, you should make extra allowances, and be aware of the possibility that the bus driver may not see you or your signals. Rear-end collisions are the most frequent type of crash involving school buses and are usually caused by another driver failing to stop while the bus is loading or unloading passengers.



When approaching a school bus, if you see amber flashing lights, slow down and proceed with caution. If the red flashing lights are activated, you must come to a complete stop. If you're approaching the bus from the opposite direction on an undivided highway, you must also stop. The single greatest threat to the safety of children who ride school buses is motorists who pass the bus when children are loading or unloading.

When approaching a bus that has its stop arm out and its red flashing lights activated, as a driver:

- You must stop no closer than 5 m (15 ft.) from the front or back of the bus.
- You must not advance your vehicle until the bus driver turns off the flashing red stop lamps and deactivates the stop arm.
- Before moving, check to see that all children have safely crossed the roadway.

Passing a school bus with red flashing lights is a serious offence and will result in a minimum fine of \$360. You don't have to stop for a school bus if you're travelling in the opposite direction on a divided highway. Some cities, towns and villages may have a bylaw prohibiting the use of flashing red stop lamps and stop arms on school buses. In those communities you're allowed to pass the bus. Drivers aren't required to stop for buses displaying four-way hazard lamps; **however, use caution, go slowly and always watch for children crossing.**

Sharing the road with motorcycles

When a motorcycle and a four-wheel vehicle collide, the motorcyclist is at a high risk for being killed or severely injured. Since motorcycles are more agile than cars, their actions are more difficult to predict and their size makes them hard to see.

Most motorcycles are wired so that their headlights are on at all times, making it easier for you to see them. Be alert for motorcycles that don't have their headlights on. During motorcycle season, check twice before making a lane change or turn – once for cars and trucks, and once for motorcycles and bikes.

When passing a motorcycle, ensure you leave adequate distance ahead of the motorcycle before you pull back in to the lane. Failure to leave sufficient room can be extremely dangerous for the motorcyclist.

The same three-second following distance should be given to motorcycles as is given to other vehicles. Following too closely may cause a motorcycle rider's attention to be distracted from the road and traffic ahead.



3.4 Sharing the road

Motorcyclists are allowed to ride two abreast but most riders prefer to have a full lane width. A skilled motorcyclist is **constantly changing** positions within a lane to increase his ability to see and be seen, and to avoid objects on the road. Never move into the same lane beside a motorcycle, even if the lane is wide and the motorcyclist is riding to one side. It is not only illegal, it's extremely hazardous. When overtaking a motorcycle or bicycle in your lane, you must pass in the same manner as you would pass a car.

Bad weather and slippery surfaces cause greater problems for motorcycles than for cars. Allow more following distance for motorcycles when the road surface is wet and slippery. These conditions create stability problems.

Being aware of these situations can help you share the road safely with all cyclists.

New motorcyclists are required to display a Motorcycle Graduated Driver Licensing (MGDL) placard on their licence plate identifying them as new riders. Learners are required to display a red 'L' placard and Novice riders must display green 'N' placards. Please use caution when passing or following a new rider and give them plenty of space.



Sharing the road with bicycles

Bicycles are vehicles. More and more people are using bicycles for transportation, not only for recreational purposes, but increasingly for getting to and from work.

Drivers of motor vehicles must learn to share the road with bicycles. Cyclists aren't permitted to use the sidewalk. Therefore, motorists must realize that cyclists are required to use traffic lanes.



Some communities have lanes designated exclusively for bicycles or lanes designated to be shared by bicycles and vehicles. It's important to become familiar with the regulations of each community you drive within.

There is also a class of bicycle called power-assisted bicycles, commonly known as e-bikes or electric bicycles, and many are designed to look like scooters equipped with pedals. These types of vehicles use an electric motor to provide assistance to the operator up to a maximum speed of 32km/hr. For more information on e-bikes (power-assisted bicycles), please visit www.sgi.sk.ca or call our Customer Service Centre at 1-844-TLK-2SGI (1-844-855-2744).

Sharing the road with e-scooters (electric kick scooters)

E-scooters (also known as electric kick scooters or electric scooters) are known as limited speed motor vehicles and are permitted in communities, towns, or cities that have specific e-scooter bylaws in place. To see if they're legal in your community, please reach out to your municipality directly.



E-scooters don't need to be registered and don't require a driver's licence, but users must be at least 16 years old, wear an approved helmet, follow all municipal laws and provincial regulations and legislation.

If e-scooters are allowed on public roads in a community, motor vehicle drivers and other road users must learn to share the road with e-scooters. It's important to know the rules within each community that you drive in. For more information on e-scooters, please visit www.sgi.sk.ca/e-scooters or call our Customer Service Centre at 1-844-TLK-2SGI (1-844-855-2744).

Sharing the road with tow trucks and vehicles rendering assistance on the roadside

When a vehicle used exclusively for towing or rendering assistance is stopped on a roadside with its amber or amber and blue lights flashing to help a disabled vehicle, drivers must slow to 60 km/h when passing. This does not apply to vehicles travelling in the opposite direction on a divided highway. However, this does apply when travelling in the opposite direction on an undivided highway.



Sharing the road with funeral processions

Funeral processions have special privileges and should not be interfered with or interrupted. They must, however, obey all traffic signs and signals – unless all drivers with the right of way stop to permit the procession to proceed.



3.5 The concept of gates

3.5 The concept of gates

The concept of “gates” is introduced to help you understand how to deal with vehicles around you.

Imagine four gates surround your vehicle at all times. One gate is located in front of the vehicle, one is behind and one is on each side of the vehicle.

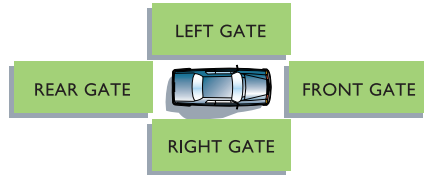

When you're travelling alone in the centre lane of a road where there are three lanes provided in the direction you're travelling, all four gates are open to you. This means you can move ahead, slow down and drop back, or move to your right or left, and still continue uninterrupted movement.



If a gate is open you can drive into it whenever you want to. A safe driver **always** tries to have at least **two open gates** to provide options for emergency movement.

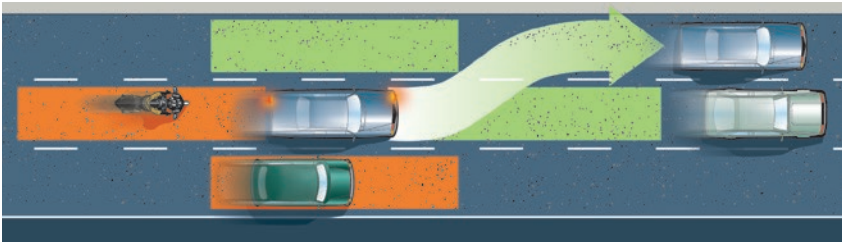

If a gate is closed – by another vehicle, a curb, a guardrail or even deep snow – you lose the opportunity to move into the area that gate controls.

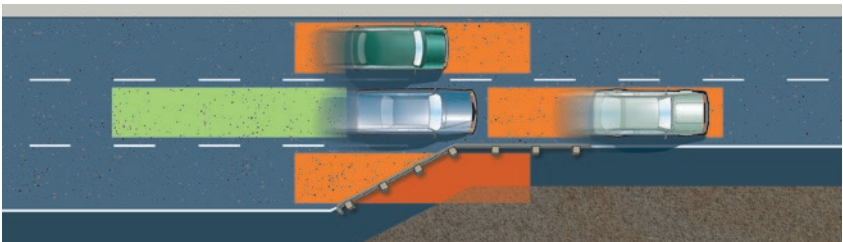

Check your mirrors to ensure you know which gates are open. You need to check your inside mirror and your left outside mirror often. When you're a more experienced driver, start using your right mirror, if you have one.

While you aren't required to identify a vehicle in detail, you should know whether the rear gate is open so that you could drop back if you wished.

If the vehicle behind you is tailgating, then your rear gate is closed. You need to leave extra following distance ahead to allow room if you have to stop. Increase your following distance to five or six seconds (see "Using time to estimate your following distance," page 85).

How often you check your mirrors depends upon the number of lanes and the amount of traffic. If you've ever been surprised by a vehicle overtaking you, then you're not looking in your mirrors often enough.

3.6 Blind spots

A "blind spot" is an area alongside your vehicle that you can't see when using any of your mirrors. It's important to check these blind spots to ensure your side gates are open, particularly if you're going to change lanes.

A quick glance over your shoulder, or "shoulder check," can allow you to see the entire side gate area of your vehicle, which could be a blind spot.

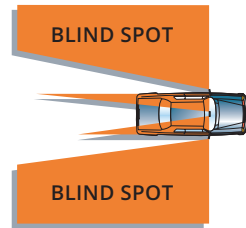

Shoulder check your blind spot for the gate you're driving into. For the left side, turn your head left until you are looking along your shoulder. You're checking to see if there is a vehicle closing your gate. If there is something there, don't try to move into that space. To check the right side, you need to turn your head to the right.

Watch out for motorcyclists and bicyclists, especially during low light conditions (dusk and dawn) or during periods of inclement weather, as these vehicles are small, fast and very manoeuvrable and may be easy to miss during a shoulder check.

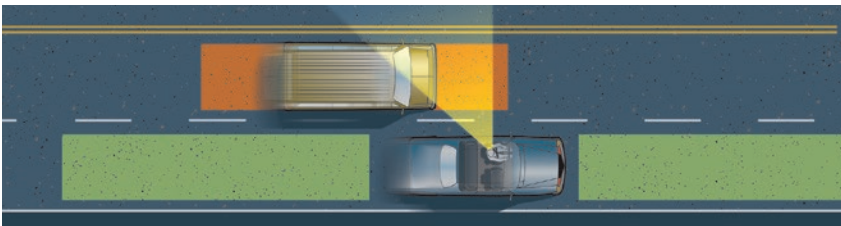

For your own safety and the safety of other motorists, don't drive in other drivers' blind spots. Move forward, or drop back, as soon as you notice this situation.

The blind spot can be significantly reduced if your mirrors are properly adjusted (see page 100).

3.7 Directional dividing lines

Yellow directional dividing lines separate traffic travelling in opposite directions.

White line markings are used to separate traffic travelling in the same direction.

Freeway lanes, as well as some city street lanes, which are ending will usually be marked by double wide lines painted on the pavement. If you're driving in a lane marked with double wide lines, be prepared for the lane to end. You'll have to exit the freeway, turn at the next intersection, or merge. Look for signs.

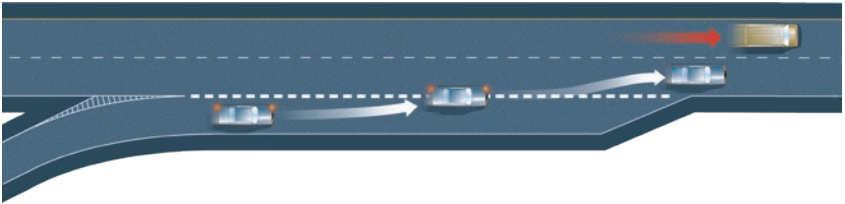
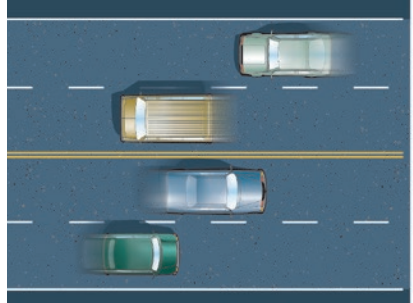

Vehicle A may pass if the road is clear ahead and behind.

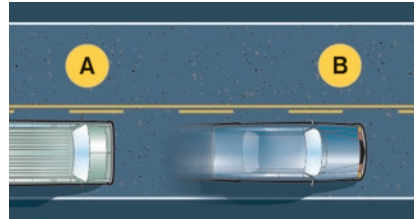
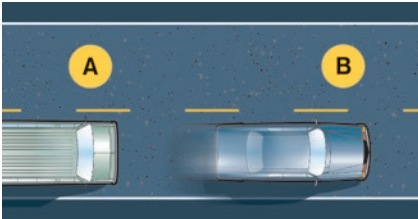

Vehicle A must not pass or make a left turn between intersections.

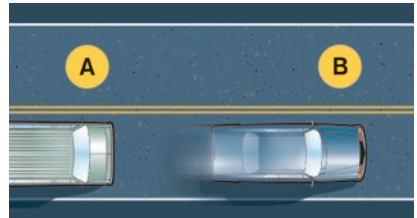
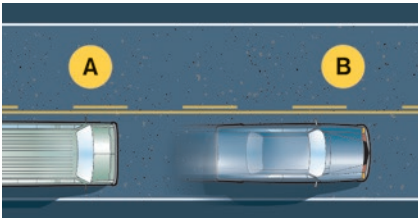

3.8 Traffic lanes

On roads with marked lanes, you must travel entirely in one lane. Where there are no lane lines marked, you should travel as if there were markings there. Changing lanes is permitted only when safe to do so.

Where a solid line separates lanes, you may not move across the solid line. The only exceptions are double lines in the centre of a highway where the line nearest you is a broken line (see the preceding illustrations) or centre turning lanes (see page 45).

3.9 Lane position

On highways or rural roads, keep to the right of your lane.

In urban areas, you'll usually drive in the middle of the lane. However, your position in the lane should allow you to see as much as possible.

Your lane position provides information to other drivers. If you intend to turn left, move to the left side of the lane. If you're going to turn right, move to the right side of the lane, but be careful to leave enough room for passing parked vehicles.

At some intersections, signs or traffic lights indicate two or more lanes may be used to complete a turn. At these locations, you must approach the intersection and complete the turn in the same relative lane position.



3.10 Lane selection

Choose the driving lane that gives you the best vision and allows you to keep the maximum number of gates open.

- On slippery surfaces, pick the part of the lane that offers the most traction.
- When turning at intersections, choose the lane that the law says you must take (see “Turning,” page 40). On a divided highway use the left lane to approach a left turn off the highway.
- On a multi-lane divided highway the left lane is intended for vehicles to pass slower moving right lane vehicles or for emergency vehicles. The maximum speed posted is the maximum under ideal road conditions. See page 113 for safe merging on a freeway.

It's not a good practice to drive on the shoulder portion of the road. The area of the roadway to the right of the solid white line is designed for stopped vehicles. As well, the shoulder can be used for emergency manoeuvres, or preparing to make a right turn from a highway. The shoulder is not an extra driving lane. Some highways have rumble strips on the shoulder, and in some cases on the centre line, to alert drivers when they drift out of their lane.

3.11 Signalling

You must turn on your signal lights in advance of your turn or lane change. A good rule when driving at speeds under 60 km/h is to signal at least 30 m before turning. At higher speeds, signal at least 150 m from the corner.

When changing lanes, you must signal and do mirror and shoulder checks before you begin to move out of your lane.

If your signal lights or brake lights fail, these hand signals must be used.



Left turn



Right turn

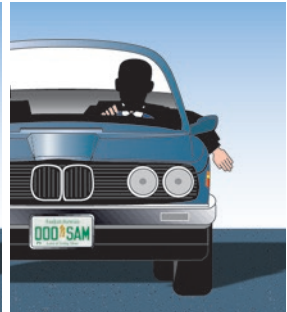

Stopping or slowing abruptly

Turn signals

When you use turn signals, you're saying, "I intend to turn or change lanes." If you wait until you're actually turning or changing lanes before you signal, you're not telling other drivers what you intend to do. They can already see that you're turning.

The procedure when you plan to turn or change lanes:

1. Assuming that you know the status of your gates and are properly positioned for the turn, signal.
2. Check your mirror.
3. Shoulder check your blind spot for the gate you are moving into.
4. Start the turn or lane change.

If you are approaching an intersection and want to change lanes, complete your lane change and cancel your signal before entering the intersection or wait until you pass through the intersection before turning on your signal and changing lanes. This helps to keep intersections safer and avoid confusion.

3.12 Changing lanes

The procedure for changing lanes:

1. Determine the need to change lanes well in advance. Make sure you know the conditions of your gate.
2. Signal your intention to change lanes.
3. Check your mirrors to see that the gate is open and that no one else is moving into it.
4. Shoulder check to look for vehicles or obstructions in your blind spot.
5. Look where you want the vehicle to go and steer there.
6. Accelerate gently and steer the vehicle to the position where you're looking.
7. When you're almost completely in the new lane, look ahead to the point where you intend to drive and your steering will adjust.
8. Cancel signal. Check the condition of your new gates. Adjust your speed.

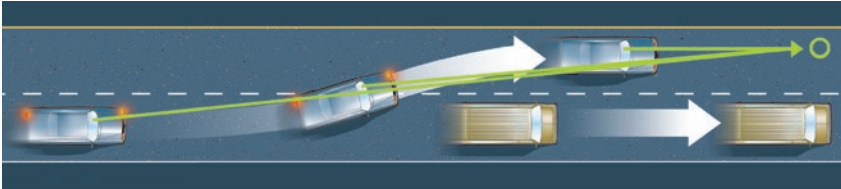

When moving through more than a single lane, make the change as one continual action. Only one signal is required, and don't forget to shoulder check.

3.13 Passing

When meeting other vehicles, you must keep to the right of the centre line of the roadway.

Head-on collisions are usually fatal. Driver distraction (e.g., texting/talking on a cellphone, eating, etc.), driver impairment (fatigue, alcohol, drugs) or driver errors, such as faulty judgment or techniques while passing, are often contributing factors in these collisions..

When passing, it's very important to keep the time spent on the wrong side of the road to a bare minimum.

When passing:

1. Make sure the pass is legal, safe and necessary. Don't cross solid or double solid yellow lines. Don't pass on the crest of a hill, before a curve, at intersections or any place where your sight distance is limited.
2. Maintain a minimum three-second following distance between you and the vehicle you are following (see "Using time to estimate your following distance," page 85). When you decide to pass, accelerate to build up speed before passing. The greater the difference in speed between you and the vehicle you're passing, the shorter your passing time will be.

3.13 Passing

3. Continue to accelerate throughout the entire pass. Don't slow down until you're back in your original lane and well in front of the vehicle you just passed. **Keep in mind that it's illegal to speed even when passing.**
4. Wait until you see the vehicle being passed in your inside rear-view mirror before pulling back into your travelling lane. Remember, you must signal, check your mirrors and shoulder check to ensure it's safe to re-enter your travelling lane.

Note: At high speeds, the lane change is more gradual and takes longer to complete.

When passing other vehicles, you must always pass on the left except:

- where there are two or more traffic lanes in your direction of travel
- any time the vehicle ahead is about to make a left turn and it is possible to pass safely on the right **without driving on the shoulder**

You may not pass any vehicle that is stopped at an intersection to permit pedestrians to cross.

When being passed on the left by another vehicle, stay to the right of your lane and maintain your speed. Don't accelerate or obstruct the passing vehicle from returning to the right lane.

Passing Lanes

Passing lanes are designed to allow vehicles to pass safely and improve the flow of traffic. A passing lane is an additional lane added to a highway that permits a slower vehicle to move into the right hand lane, while a faster vehicle can pass safely in the left hand lane.

The right hand lane is designated for travel and the left hand lane is only to be used for passing. Maintain your speed when moving into the right hand lane and do not speed up.

Signs will alert you of a passing lane ahead. Have patience, maintain a safe following distance and wait for the passing lane instead of using the oncoming traffic lane, which can be dangerous.

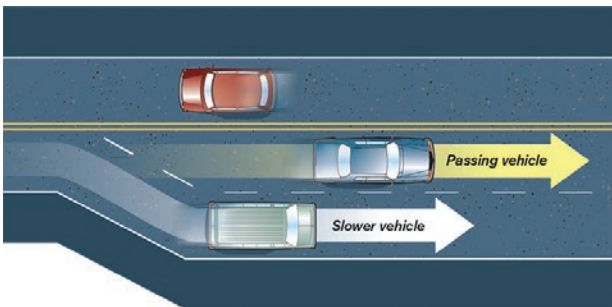

3.14 Bus lanes and bicycle lanes

Major centres often have designated bus and/or bicycle lanes that other motorists must stay out of unless they need to enter them to turn, park or for entering a lane or driveway.

Bus lanes are marked by a lane sign that indicates the time and days of operation of the restriction. The sign has a diamond on it, as well as a bus symbol. In some centres, the lane itself has diamond markings installed in the pavement. On these designated streets, curb lanes are reserved for transit vehicles during the rush hour, or peak driving times.

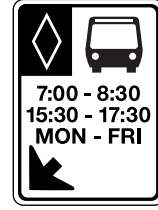

When bus lane hours are in effect, no one is allowed to operate a vehicle, other than a bus or an emergency vehicle, in the designated curb lane, except for the purpose of making a right turn onto, or off of, a street block where a bus lane is in effect. Only buses, emergency vehicles or accessible taxicabs loading or unloading non-ambulatory passengers are allowed to stop in a designated bus lane.



This sign indicates the street you're turning to has a designated lane.



Bicycle lane

Bicycle-only lanes are dedicated for cyclists and are similar to bus lanes. Vehicles aren't allowed in bicycle-only lanes except for the purpose of making a right turn, accessing a parking space or entering a lane or driveway.

3.14 Bus lanes and bicycle lanes

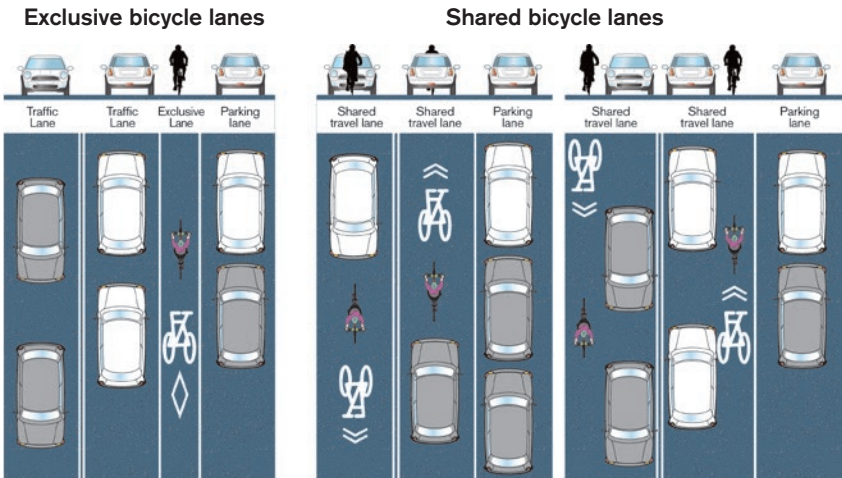

Designated bicycle lanes may be exclusive for bicycle use (left) or shared with motor vehicle traffic (right).

Pavement marking may vary between communities.

Shared bicycle lanes

A chevron and bicycle symbol designate a shared bicycle or “sharrow” lane.

Sharrows use pavement markings painted on a roadway to encourage cyclists and motorists to share the lane. They are generally intended for use on roadways with lanes that are wide enough for side-by-side bicycle and vehicle operation. However, motorists should always pass cyclists at a safe distance and should not assume that the sharrow indicates that they can pass within the travel lane. Depending on the positioning of the cyclist, it may be necessary to change lanes in order to pass safely.

Sharrows do not designate a bicycle lane and should not be treated as such. While some cyclists will ride down the centre of the arrow, in many locations, the sharrow marking simply indicates cyclists and motorists are to share the lane and isn't an indication of where a cyclist rides within the lane.

3.15 Turning

Right turns

When approaching an intersection or driveway that requires a right-hand turn, move as close to the right curb or right edge of the road as possible.

General procedure:

1. Plan your right turn well in advance. Signal, check your rear gate and check your blind spot. When safe, move as close to the right as possible.
2. Check for traffic, pedestrians and other real or potential hazards in or near the intersection. A basic left, straight ahead, right, left sweeping pattern will be sufficient.
3. Slow down (and shift to a lower gear if you are in a manual transmission vehicle).
4. Check again for real or potential hazards.
5. If there are no real or potential hazards, complete your right turn into the first available driving lane.

See page 77 for rules regarding turning right on a red light.

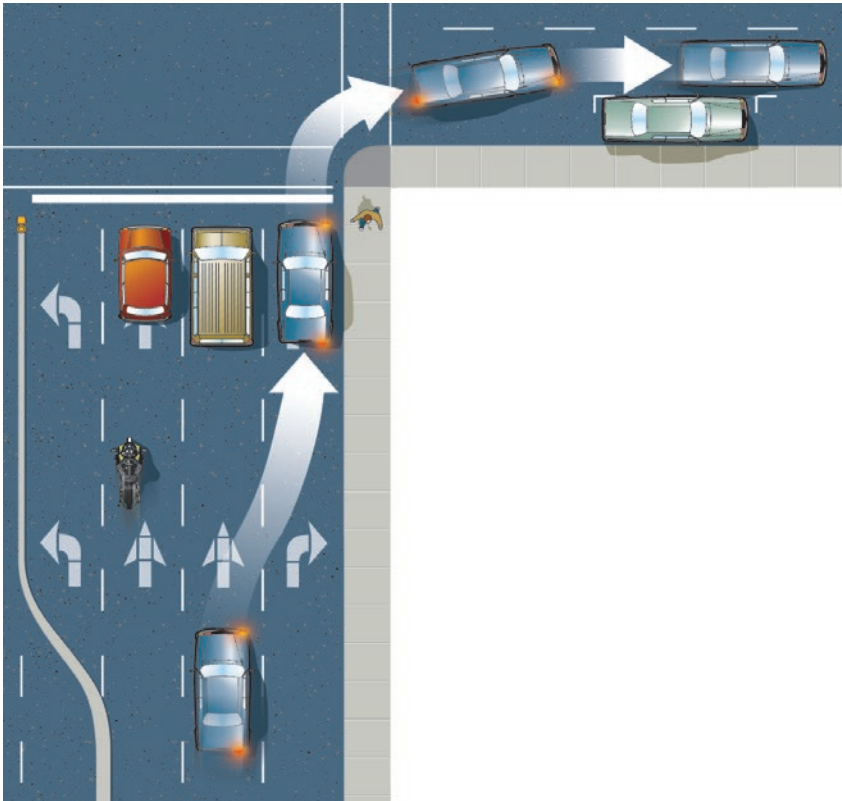

3.15 Turning

When a vehicle is parked in the lane closest to the right curb and near the intersection, the driver must move into that lane at the first opportunity before turning, keeping as close to the right curb or edge of the road as possible.

Drivers may not make turns from the main driving lane.

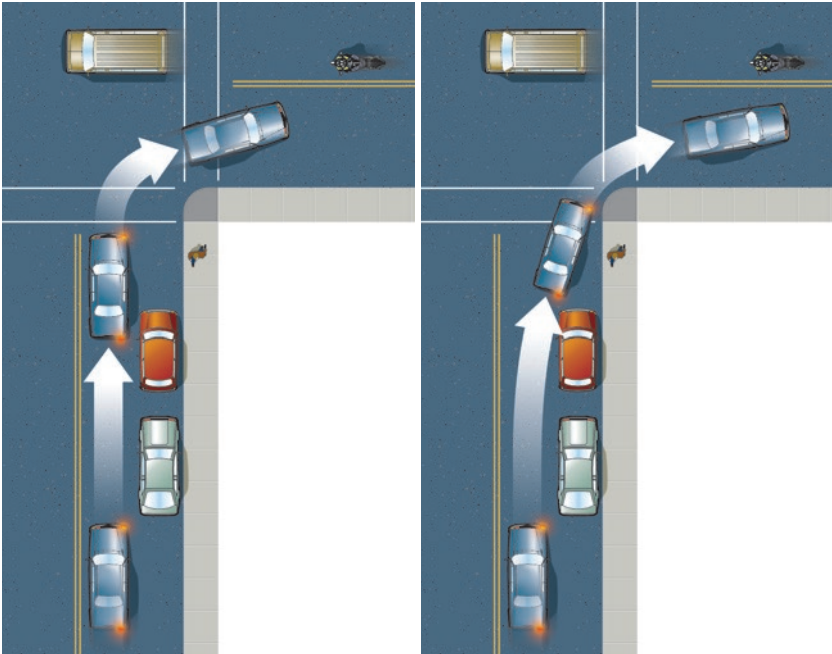

 Incorrect

 Correct

Left turns

Left turns are more dangerous than right turns because you have to cross traffic coming from at least two directions. This means that your searching pattern is very important and you should continue to search as you cross the intersection. When you intend to turn left across the path of any vehicle approaching from the opposite direction, you must yield the right of way to the oncoming vehicle. When making a left turn, you must approach the intersection and complete the turn in the left-most lane available for your direction of travel.

General procedure:

1. If a lane change is required, decide well in advance to make your left turn. Signal and check your rear gate and blind spot to see if there is a vehicle close to you. Move safely into the left side of the left lane.
2. Check for traffic, pedestrians and any other real or potential hazards that may be in or near the intersection. Use the basic left, straight ahead, right, left sweeping pattern.
3. Slow down (and shift to a lower gear if you are driving a manual transmission vehicle).
4. Check again for real or potential hazards. Watch out for motorcycles when completing a left turn. Motorists failing to identify oncoming motorcycles when making a left turn is a significant contributing factor in collisions involving motorcycles.
5. If you have to stop in the intersection to wait for oncoming traffic, be sure to keep your vehicle parallel to the lane and your front wheels straight. That way if you're hit from behind, you will not be pushed in the path of oncoming traffic.
6. If there are no potential hazards, complete your left turn into the first available driving lane.

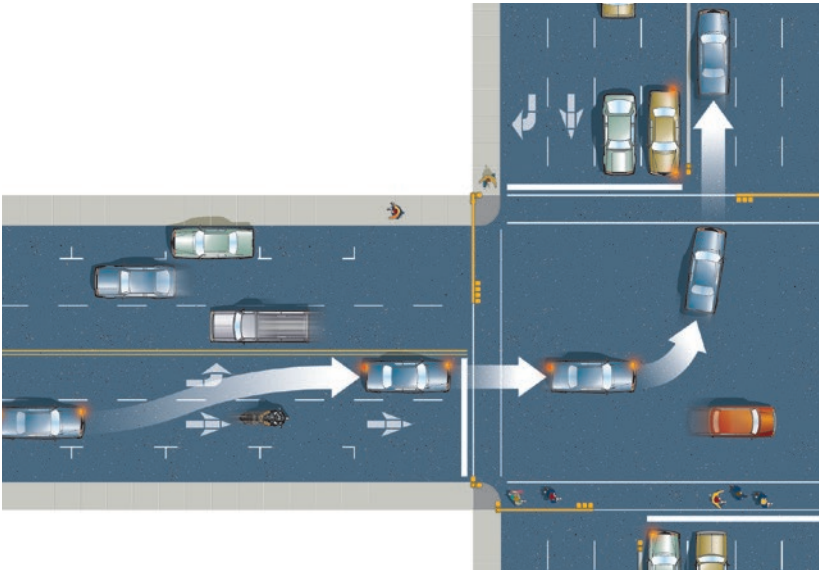

3.15 Turning

A left turn from a one-way street to a two-way street should be made as close as possible to the left edge of the roadway. If there are no cars parked in the curb lane, you can move into that lane in advance of the corner. If there is a car in the curb lane, be sure the driver is turning and not pulling over to park before entering the lane.

When you make your turn onto the two-way street, enter into the lane immediately to the right of the centre line.

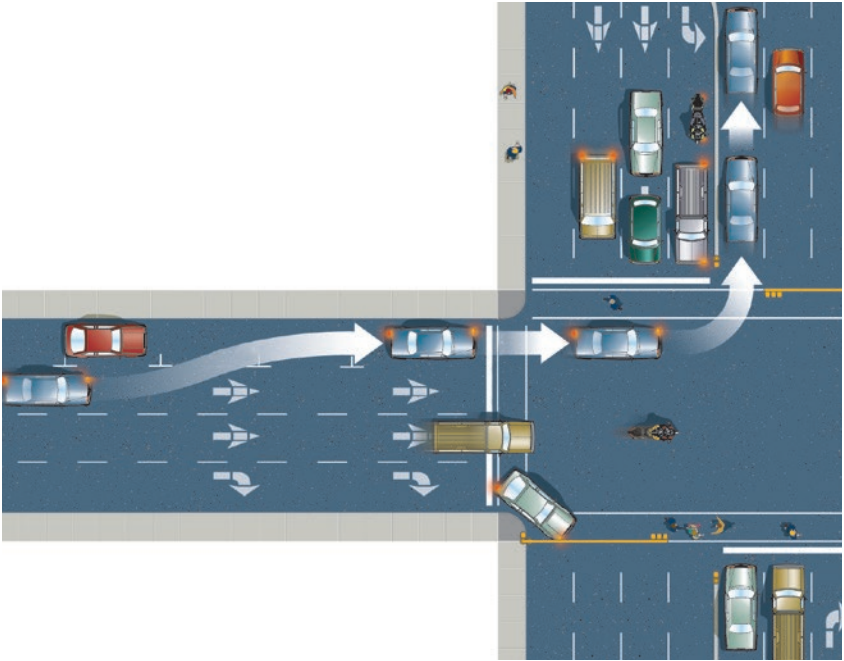

For a left turn from a one-way street to a one-way street, start the turn from the left edge of the roadway and complete the turn in the left-most driving lane.

When a vehicle is parked in a lane closest to the left curb and near the intersection, the driver must move into that lane at the first opportunity before turning.



For a left turn from a two-way street to a one-way street, turn from the lane next to the centre line and enter the one-way street into the left-most driving lane.

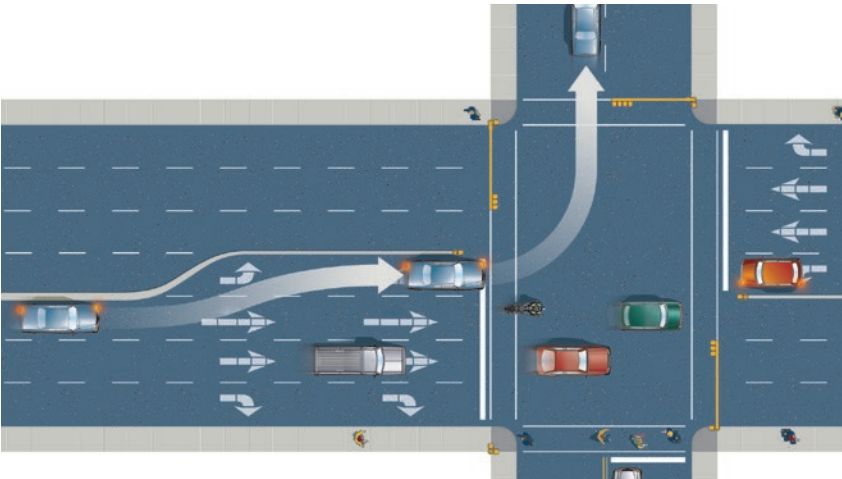

3.16 Centre turning lanes

This sign indicates a two-way left turning lane. These are used in many communities, especially larger centres, to improve traffic flow and to allow for easier access to properties in mid-block.

The diagram indicates the correct turning procedure. Here are some other points to keep in mind when using centre turning lanes:

- Enter the two-way left turning lane only at the point adjacent to the property you want to access (see arrow for car A).
- Left turns from either direction may be made from the two-way left turning lane.
- When leaving a driveway or parking lot, pick a gap in traffic, complete the turn by driving through the centre turning lane and into the first available driving lane as quickly as possible (see arrow for car B).
- The centre turning lanes may not be used as a passing lane or as a driving lane.
- Where a centre turning lane is provided, you may not make a left turn from any other lane.

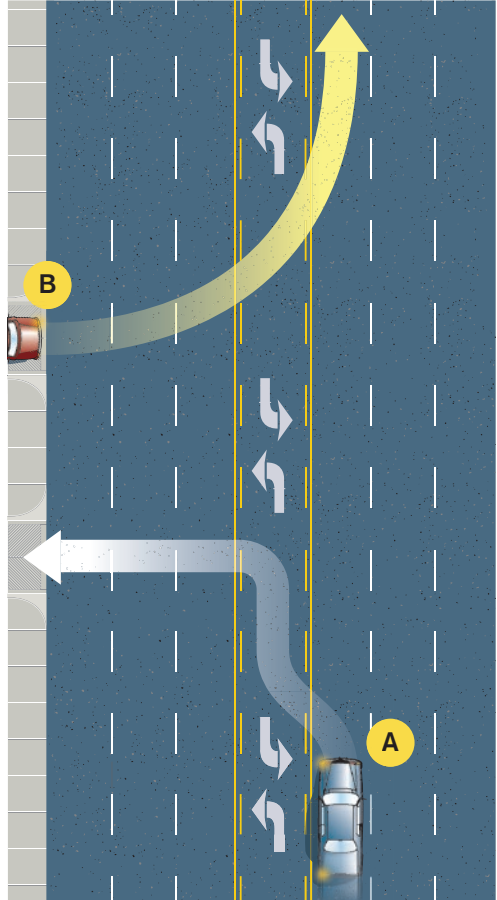

3.17 Right of way

Uncontrolled intersections

At an intersection where there are no stop signs, yield signs, traffic lights or police directing traffic, and two vehicles arrive at the intersection at approximately the same time, the driver of the vehicle on the left must yield the right of way to the driver of the vehicle on the right.

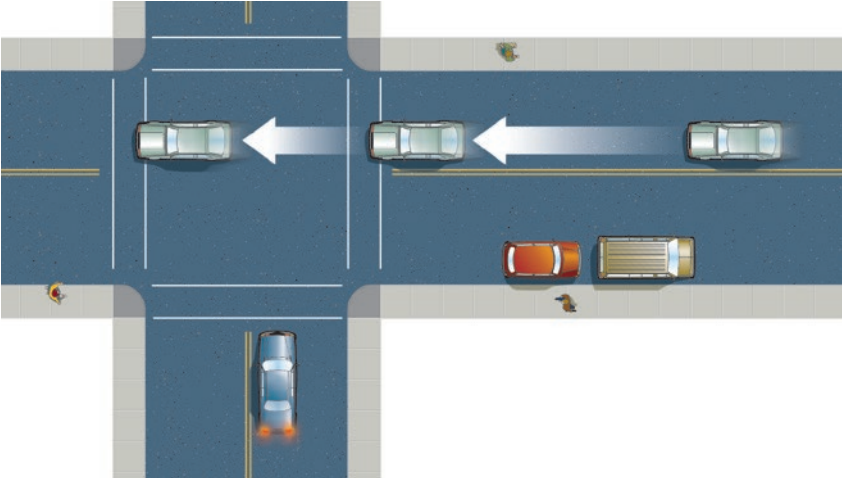

This rule also applies to T-intersections.

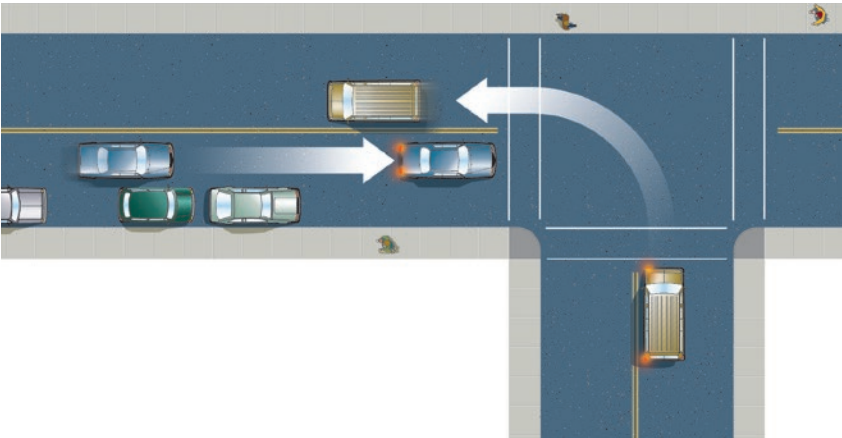

3.17 Right of way

When turning left, you must yield the right of way to any vehicles coming toward you if they are close enough that your turn would interfere with them.

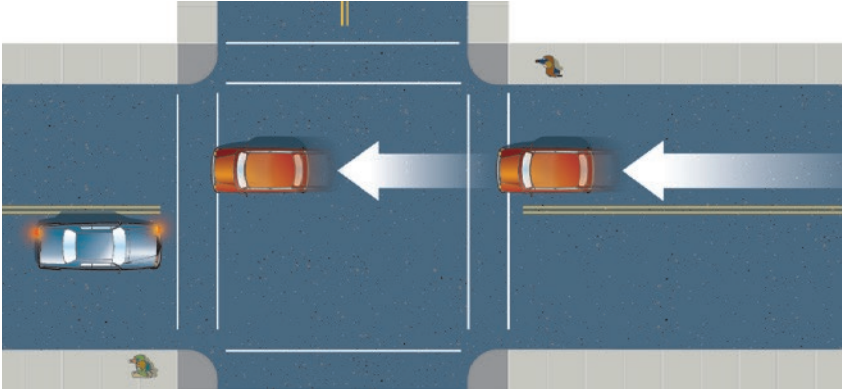

When entering a provincial highway from any other road, you must yield the right of way to any vehicles travelling on the provincial highway and to any pedestrian closely approaching the intersection.

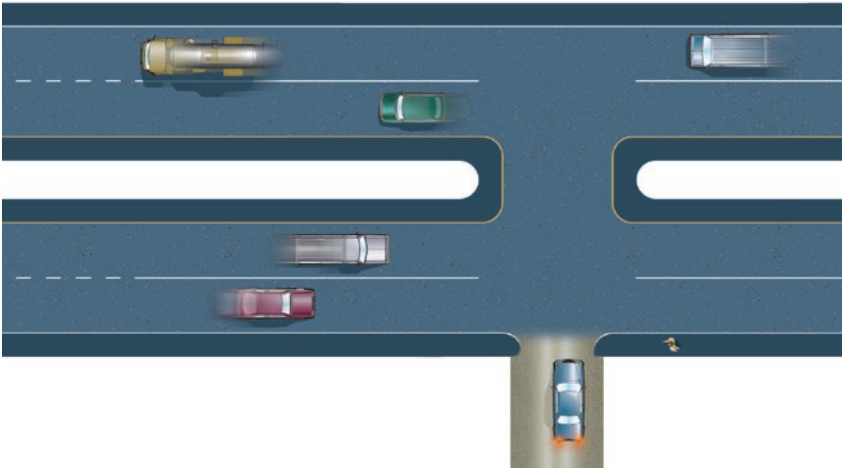

When entering a street, road or highway from a private road, lane or alley, you must yield the right of way to any pedestrians on the sidewalk and to any vehicles on the street, road or highway.



Controlled intersections

At any intersection where a yield sign is present, drivers facing the sign must yield the right of way to any other motorist approaching the intersection.

At three and four-way stops, courtesy dictates that the first vehicle that stops should be given the right of way. The remaining three then yield the right of way to the driver on their right.

At two-way stops, vehicles must remain stopped until all cross traffic passes. When two vehicles arrive around the same time to the opposite stop signs and one of the vehicles is turning left, the driver turning left must yield the right of way to the driver going straight. If it's safe, the vehicle turning left can go next, even if another vehicle arrives in the meantime, and plans to go straight. The left turning vehicle can turn left while the next vehicle advances to the stop line. This keeps traffic flowing. When opposing vehicles are both going straight, the drivers can proceed at the same time.

In any case, if you're at a stop sign you must yield to vehicles and pedestrians and may not proceed until it's safe.

All drivers have a moral and legal responsibility to avoid collisions. If you have the right of way at an intersection and a driver refuses to yield to you, you're responsible from a safety standpoint to avoid a collision, rather than insist upon your right of way. Don't forget the old adage – "You could be right – dead right!"

Construction or maintenance vehicles

At all times, you must yield the right of way to any highway construction or maintenance vehicles that have their warning lights flashing.

Zipper merge

When a lane is closed in a construction zone, you might need to make a zipper merge. A zipper merge means drivers use both lanes of traffic until the lane ends, and then alternate in “zipper” fashion into the open lane. Vehicles in the lane that’s ending must signal, shoulder check and merge when safe, while each driver in the continuing lane should let one vehicle in. Sometimes both lanes are merging into a new lane and drivers in both lanes must signal, shoulder check and take turns merging when it’s safe.

Zipper merging is beneficial because it makes traffic flow more quickly and efficiently for drivers in both lanes. It also creates a sense of fairness and equity since all lanes are moving at the same rate. Zipper merging also helps reduce:

- differences in speeds between two lanes
- the overall length of traffic backup
- congestion on freeway interchanges



Always pay attention and follow any posted signs you see in a construction area. Zipper merge signs may not always be present, but zipper merging is allowed and recommended in construction zones.

Remember to be courteous, merge when safe and you’ll zip through quickly.

3.18 Stopping positions

There are several different situations you may see when preparing to stop at an intersection with a stop sign or traffic light. Where you should stop and your stopping position, is determined by markings on the road. You must stop:



At the nearest crosswalk, whether marked or not.



At a clearly marked stop line.



Where there is no stop line, sidewalk or crosswalk:

- Within three metres of the intersection in a town, city, village or hamlet.
- Within 10 metres of the intersection in a rural area.

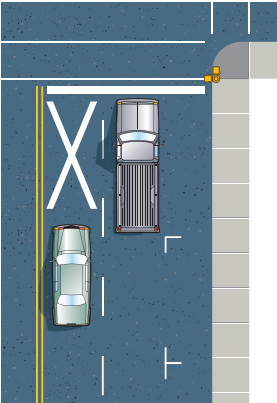

Behind the clearly marked X.

3.19 Interchanges

Roundabouts

In a roundabout, the vehicle on the right must yield to the vehicle on the left.

In the diagram, traffic indicated by red arrows in yellow lanes must yield to traffic indicated by white arrows in green lanes. Traffic entering the roundabout must yield to traffic in the roundabout.

In this diagram:

- B and C must yield to A.
- E must yield to D while F and D proceed.
- H must yield to G.



When you're leaving the roundabout use your right-turn signal to warn other drivers of your intention to exit.

It's recommended that for safety, entry into the right lane be used mainly when intending to exit at the first available exit point. If you are intending to proceed beyond the second exit, you should drive in the left lane.

Diverging Diamond Interchange

A diverging diamond interchange is new to Saskatchewan, but is gaining popularity across North America. This type of interchange is designed to improve safety and reduce delays by maintaining the flow of traffic. The key feature of this type of interchange is that traffic on the overpass crosses over to the opposite side of the road at one traffic-signal controlled ramp and then returns to the proper side at the next traffic-signal controlled ramp. The crossover allows higher volume left-turn traffic to proceed with little disruption or interruption.

When you encounter this type of intersection:

- Watch for lane designation signs as well as pavement markings to guide you into the correct lane (see “Lane selection,” page 34).
- **Traffic going straight** – watch for lane designation signs and ensure you’re in the correct lane to proceed straight. After the traffic lights, don’t panic; you will be crossing onto the opposite side of the road for a short distance before crossing back onto the proper side at the next traffic lights.
- **Traffic turning left** – watch for lane designation signs and ensure you’re in the correct lane to turn left. After the traffic lights, don’t panic; you will be crossing onto the opposite side of the road for a short distance before making your left turn.
- **Traffic turning right** – normal right-hand turn procedures apply, so watch for lane designation signs and ensure you’re in the correct lane to turn right.

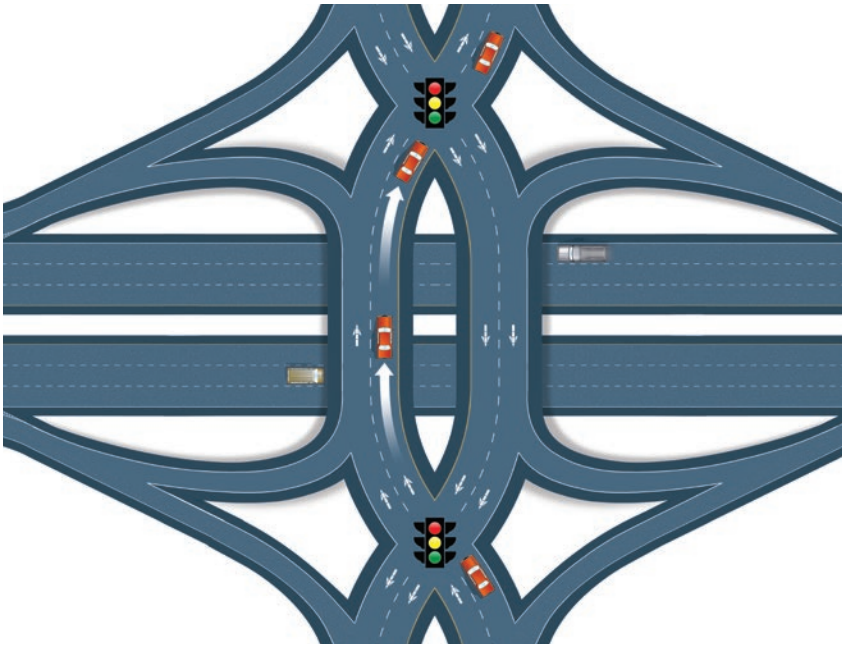

Traffic going straight

3.19 Interchanges

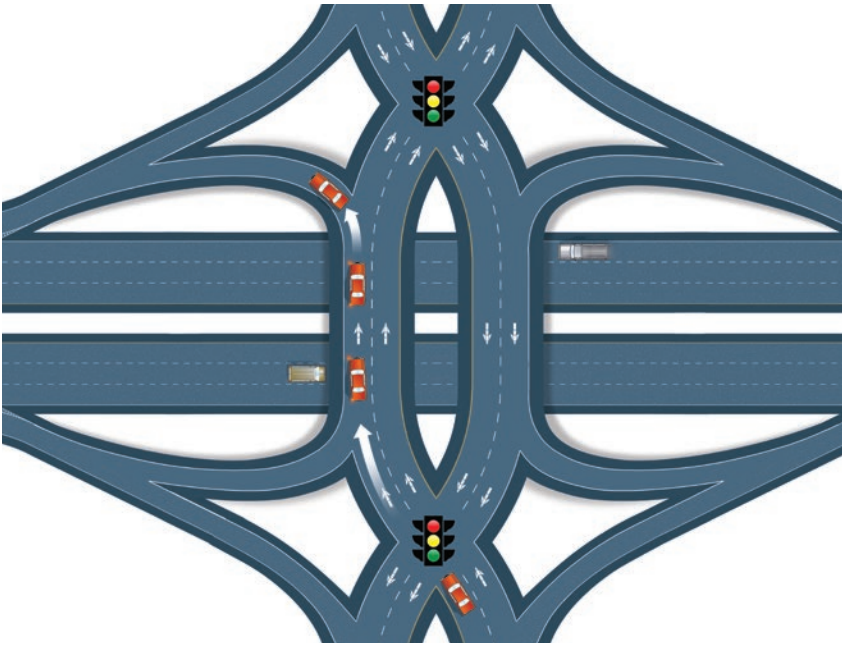

Traffic turning left

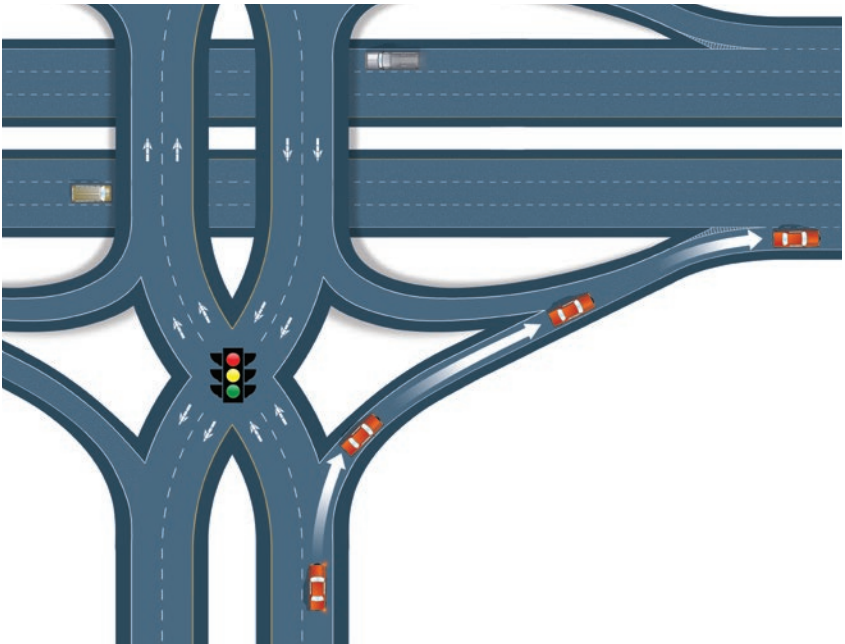

Traffic turning right

Restricted Crossing U-Turn

The Restricted Crossing U-Turn (RCUT) intersection (also known as a reduced conflict intersection) is designed to decrease collisions caused by motorists attempting to cross a four-lane divided highway.

At an RCUT intersection, drivers always make a right turn, followed by a U-turn. Motorists approaching a divided highway with an RCUT intersection are not allowed to make a left turn or drive straight through to cross the divided highway. Instead, drivers must do the following:

1. Using the entrance ramp, make a right turn into the acceleration lane to enter the highway.
2. When it is safe to do so, signal, check your mirrors, shoulder check and change lanes into the **far-left lane** to enter the U-turn lane.
3. Complete the U-turn into the acceleration lane going the opposite direction.
4. When it is safe to do so, signal, check your mirrors, shoulder check and change lanes into the far right driving lane to continue straight or into the far right turning lane to complete a right turn.
5. Remember to shoulder check when changing multiple lanes.

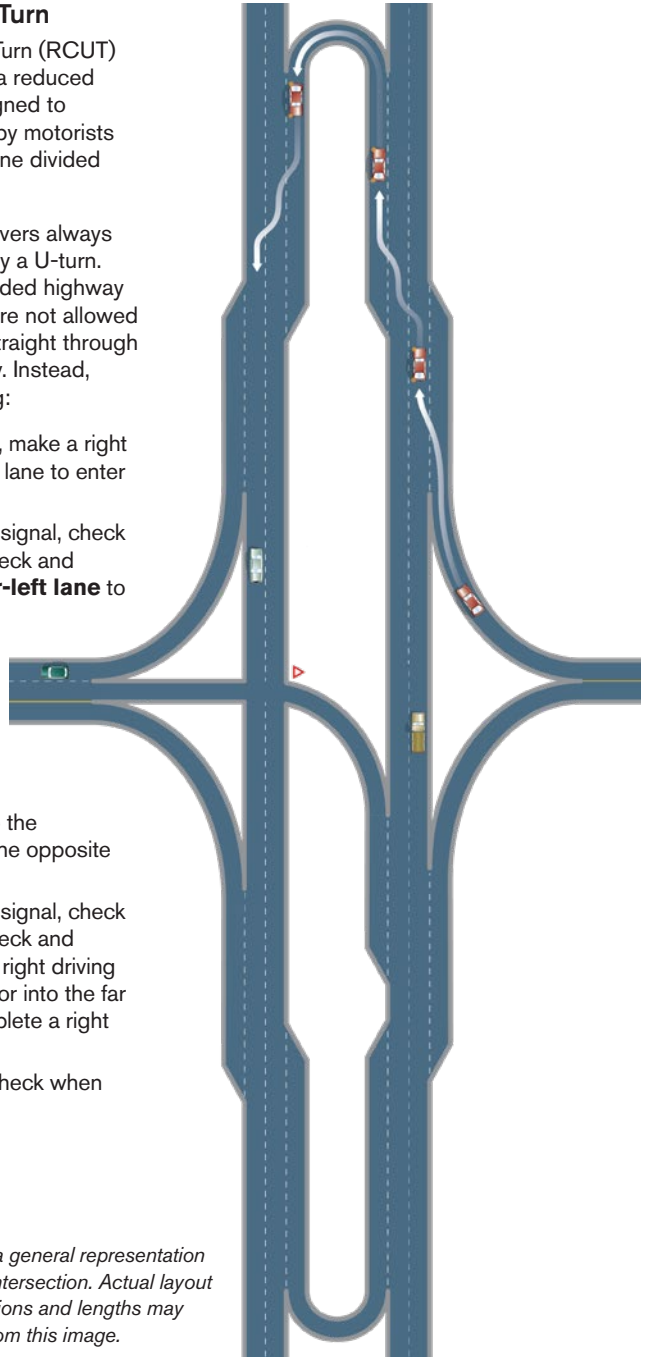

**This is a general representation of the intersection. Actual layout dimensions and lengths may differ from this image.*

3.20 Highways

Driving to the left of centre

You may not drive to the left of the roadway centre on two-way streets, roads or highways unless it's safe and there's no traffic approaching.

One-way highways

You may not travel in the wrong direction on a one-way highway.

Divided highways

Travel in the right hand driving lane and only use the left lane for passing, turning left or emergency manoeuvres.

Controlled access highways

In the case of controlled access highways or freeways, you may not enter or leave except at the exit or entrance provided.

3.21 Pedestrians

When approaching an intersection, you must yield the right of way to any pedestrians who are crossing the street.

You must stop your vehicle before the crosswalk, which will either be painted on the road or be an imaginary extension of the sidewalk. If a traffic light changes while a pedestrian is in the crosswalk, the pedestrian has the right of way.

You must stop your vehicle when directed to do so by a school crossing guard controlling a crosswalk.

You may not pass any vehicle that is stopped at an intersection to permit pedestrians to cross.

As a pedestrian, you must not attempt to cross at an intersection unless you have given motorists a chance to stop.

Pedestrians walking along a road should walk on the left shoulder, facing oncoming traffic.

Note: Pedestrians also include persons in wheelchairs, motorized wheelchairs and medical scooters.

Jaywalkers

Jaywalking is when a pedestrian crosses a roadway in violation of traffic laws, typically when crossing outside of a marked or unmarked intersection.

You must always be prepared to stop if you see a pedestrian who is about to step out in front of you. But don't encourage jaywalking by stopping and inviting pedestrians to cross. The car behind you may not be expecting you to stop and may collide with you. Also, drivers in the other lanes might not see the pedestrian crossing in front of your vehicle and may hit them.

3.22 Crossing urban streets

You may drive across a street only at an intersection, lane or alley.

Note: In some cities, crossing a street at a lane or alley is prohibited by a local bylaw.

3.23 Wheelchairs and medical scooters

The rules of the road that apply to pedestrians also apply to persons using a wheelchair, motorized wheelchair or medical scooter for medical reasons.

When approaching an intersection, you must yield the right of way to any person crossing the street who is using a wheelchair, motorized wheelchair or medical scooter. This does not apply to wide streets if the person in the wheelchair is at a safe distance from your side of the street.

You must stop your vehicle before the crosswalk, which will either be painted on the road or be an imaginary extension of the sidewalk.

You may not pass any vehicle that is stopped at an intersection to permit persons using wheelchairs, motorized wheelchairs or medical scooters to cross.

Persons in wheelchairs, motorized wheelchairs or medical scooters must not attempt to cross at an intersection unless they have given motorists a chance to stop.

The sidewalk should always be the first choice while using a wheelchair, motorized wheelchair or medical scooter. When there is no wheelchair accessible curb, get onto the sidewalk using the first available driveway.

Like pedestrians, persons using wheelchairs, motorized wheelchairs or medical scooters travelling along a road where no sidewalk exists should travel on the left shoulder, facing oncoming traffic. Wheelchairs, motorized wheelchairs or medical scooters should also have a brightly coloured flag attached to increase visibility to motorists.



3.24 Motorcycles

Although two motorcycles are permitted to drive in the same traffic lane, it's not recommended practice to operate directly alongside another motorcycle.

Motorcycles may not travel beside any other type of vehicle in the same lane.

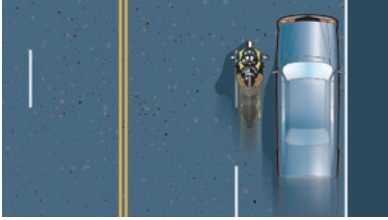

 *Incorrect*



 *Correct*

Drivers and passengers must wear an approved motorcycle helmet. If the motorcycle does not have a windshield that deflects the air stream away from the driver's face, drivers and passengers must wear safety glasses, a face shield or goggles.

For further information, refer to www.sgi.sk.ca/motorcyclehandbook.

3.25 Medians

Where a median, boulevard or ditch divides a road, you may not drive on the left side of it.

You may not cross any median, boulevard or ditch except at an intersection or where a cross-over is provided.

3.27 Headlights

It's advisable to have your lights on at all times because studies show that vehicles driven with lights on at all times are much less likely to be involved in collisions than those operated with their lights on at night only.

The law requires the use of headlights from half an hour after sunset until half an hour before sunrise, and at any time when visibility is poor.

Note: Some vehicles do not have tail lamps on when daytime running lights are being used. Always ensure you turn your headlights on at night, as it's dangerous to operate a vehicle at night without them or your tail lamps illuminated.

When using high beams, you must dim your headlights at least 200 m (650 ft.) in advance of oncoming vehicles and keep them dimmed until the vehicle has passed.



Low beams

Many drivers make the error of dimming their headlights too soon for oncoming vehicles. For example, when driving at 100 km/h, you may not have to dim your high beams until the approaching vehicle is about seven to eight seconds away from you, but a realistic approach is to dim your lights between nine and 12 seconds away.



Low beams

While you need to see the road, you shouldn't blind the oncoming driver with the glare of your lights. You may find that some drivers approaching you will signal you to lower your lights while they are up to 20 seconds away. This applies to vehicles you are meeting and vehicles you are following. To avoid blinding other drivers, make sure your headlights are properly adjusted and are in working order.



High beams

Also, turn off any spotlamps at least 500 m (1,640 ft.) in advance of an oncoming vehicle and keep them turned off until the vehicle has passed.

You don't need to dim your headlights for oncoming traffic if you're driving on a divided highway where the distance between the roadways is 22 m (70 ft.) or more (the distance is measured from left shoulder marking to left shoulder marking in each direction of travel).

You must keep your headlights on low beam within 100 m (330 ft.) and keep any spotlamps or auxiliary driving lights turned off within 500 m (1,640 ft.) when you're following another vehicle, or when you're being passed.

If you've been driving in the dark for a while, you will need up to five seconds to recover from the glare of oncoming lights. This glare recovery time tends to increase with age to the point where it sometimes takes up to 25 seconds to recover. If you suspect you have a glare recovery problem, check with an ophthalmologist or optometrist.

3.28 Night driving and low visibility

Driving at night is difficult because the area illuminated by your headlights is not all you need to see. Motorcycles, cyclists, pedestrians and wildlife are particularly difficult to see under these conditions — watch closely for them. If street lamps provide overhead lighting, you can see well ahead. If not, you must rely on your headlights. While driving at night, you should be able to see about 12 seconds travelling distance in front of you. This means that most of the time, you should be using your high beam headlights and be looking beyond the part of the road illuminated by your lights.

To reduce glare from other vehicles or lights to the rear, adjust your mirror or use a day-night mirror turned to "night." Dimming the dash lights will also improve your ability to see the road.

3.29 Choosing the right speed

Driving without a full 12 seconds of view ahead means you are over-driving your headlights. This means by the time your headlights illuminate an object on the road you'll be unable to stop before hitting it. This makes it critical to use all the other information available.

Pay attention to other vehicles on the road, which can give you clues.

If you can see the rear lights of the vehicle in front, you can be sure that no large object is between the two of you.

The most important action that you can take at night is to slow immediately when you detect something on the road ahead. Don't wait until you can see the object clearly — by that time, it will probably be too late to stop. As soon as you see something on the road, use your brakes so that you are slowing down while identifying what it is. You'll then have more time to stop or change your direction if the need arises.

3.30 Rules related to vehicles

- Tampering with a vehicle without the owner's permission is not permitted.
- Climbing into or on a vehicle without the owner's permission is not permitted.
- Throwing objects at a vehicle is not permitted.
- You may not watch a television, video screen or computer screen when driving unless the information displayed is solely designed to assist you in the safe operation of the vehicle.
- All material carried on a vehicle must be securely contained or tied down so that it cannot fall off the vehicle.
- Damages resulting from any of the above infractions may have to be paid for by the offender.
- Unless you are riding in or on the vehicle, you must not hold onto a moving vehicle.
- Passengers may not ride in or on a trailer.
- The use of hand-held cellphones while driving is prohibited, (see page 23).
- No one may ride on the exterior of a vehicle unless there is a space designed for passengers. This does not apply to construction, maintenance, firefighting, police or parade vehicles.
- Passengers are not permitted to ride between the driver and the driver's door.
- Passengers must not crowd the driver.
- Drivers must have a clear view of the road to the front, sides and rear. Aftermarket tinting is not allowed on the windshield or front side windows.
- No pedestrian, passenger or driver shall perform any stunt or activity that is likely to distract, startle or interfere with any other user of the road.
- Dropping burning material or material that could damage tires onto a road is not permitted.
- Vehicles must display a valid licence plate firmly secured to the rear of the vehicle and not obstructed in a manner that prevents the plate from being read or accurately photographed by a red light camera.

4. Traffic signs and signals

4.1 Traffic signs

Many collisions and near crashes occur as a result of drivers who ignore or fail to respond appropriately to traffic signs. It's essential that the meaning of traffic signs be interpreted correctly. Signs are classified according to their function such as regulatory, warning and information.

The easiest way to identify traffic signs is to learn to recognize their shapes and colours. For safe driving, you must recognize and obey traffic signs without hesitation.

A sign-conscious driver is a safe driver. Keep a constant look-out for signs as you move your eyes in the field of view ahead of you.

4.2 Six basic sign shapes every driver must know



Stop

The stop sign, a red octagon with white lettering, means come to a full stop and be sure the way is clear before proceeding.

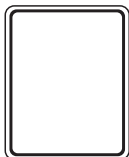

Regulatory

Regulatory signs are white rectangles or squares with black or other coloured lettering. These signs state the law, such as speed limits, parking regulations and turning and passing movements.



Yield

Yield right of way signs are triangular and have a red border on a white background.

A yield sign means you must reduce speed when approaching an intersection. Give right of way and stop if necessary if any other traffic is in, or closely approaching, the intersection.



Warning

Warning signs are diamond shaped and are yellow or orange with black letters or symbols. They warn of dangerous or unusual conditions ahead, such as a curve, turn, dip or side road.



Railway Crossing

The crossbuck is the traditional symbol at roadway-railway crossings. The colour of the crossbuck is the same as a yield sign and has the same meaning; give right of way and stop if necessary.



School Zone (New)

The new school zone signs have a pentagon shape, with a fluorescent yellow-green background and show a black silhouette of a schoolboy and a schoolgirl.



School Zone (Old)

The old school zone sign has a pentagon shape, but with a blue background and shows a white silhouette of a schoolboy and a schoolgirl. These signs are currently being replaced.









School Zone

When this sign has a “Maximum Speed” or “km/h During School Days” tab mounted underneath, it means the speed is to be observed as indicated.

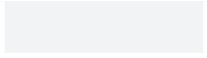

4.3 Standard sign colours

Each colour has a particular meaning.

			
Red Stop or prohibition	Blue General information or service road information	Green Indicates traffic movement such as turns which are permitted or directional guidance	Yellow General warning danger/caution
			
Fluorescent yellow-green School zone and school crosswalk ahead signs	White Regulatory	Orange Construction and maintenance warning	

4.4 Regulatory signs



One-way street or highway

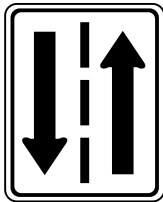

Two-way traffic

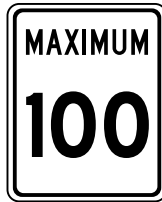

The maximum speed allowed under ideal conditions



Advance warning of a lower maximum speed zone ahead



The maximum speed allowed in a work zone*

* The fine for speeding triples when travelling greater than the posted speed limit past workers. Workers are identified as anyone within 3 km of a traffic control person, survey crew or highway workers sign identified on page 73.

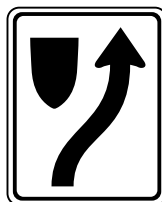

Keep to the right of traffic islands or obstruction



Do not enter

4.4 Regulatory signs



Passing permitted



Passing not permitted



U-turn permitted



No U-turn
You must not turn your vehicle around in the roadway to travel in the opposite direction



Heavy trucks should use this roadway



No heavy trucks are allowed on roadway



Dangerous goods route



Dangerous goods carriers prohibited

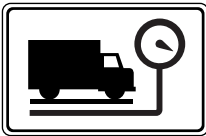

Truck inspection station

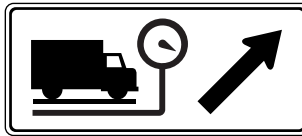

Truck inspection station exit
Arrow indicates which side of road



Over dimensional route



Weight limit of vehicle permitted on highway or bridge expressed in tonnes

4.5 Regulatory parking signs



Parking allowed as indicated



Do not stop to wait



Parking prohibited as indicated



Stopping prohibited as indicated

4.6 Regulatory pedestrian crossing signs



Pedestrian crosswalk (new)



Pedestrian crosswalk (old)



School crosswalk (new)

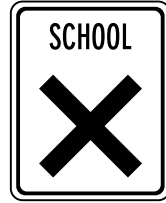

School crosswalk (old)



Pedestrian crosswalk

Traffic must stop when lights are flashing and proceed when safe

4.7 Regulatory lane designation signs

These signs may be mounted above (or to the side of) the roadway. When mounted above, each sign is centred over the lane it controls.

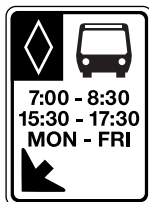

Bus lane



Bicycle lane



This lane must turn left



This lane left or through



Two turning lanes left/right

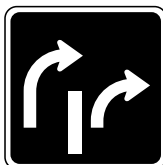

This lane left or right



This lane all movements



This lane through only

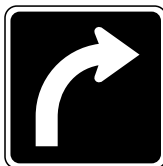

This lane must turn right



This lane right or through

4.8 Regulatory turn control signs

These signs may be accompanied by a tab that indicates the sign is only in effect during certain hours of the day.



No left turn



No right turn



Go straight or
right turn only



Go straight or
left turn only



Turn right or left



Go straight



Turn left only



Turn right only



No right turn on red
*Wait for green
light before making
a right turn*



Centre
turning lane

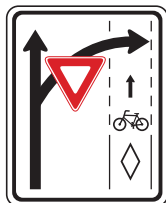

Turning vehicle
yields to bikes

4.9 Warning signs

Modern traffic signs use symbols instead of words. However, drivers must be familiar with both types of signs. Where applicable, both signs are shown.



Two-way traffic ahead



Divided highway ahead



Road surface slippery when wet



Bump or rough road ahead



Obstruction
Pass to either side



Divided highway begins
Keep to the right



Section of roadway regularly crossed by deer



Steep hill ahead
Shift to lower gear or slow down if going down very steep hill

The following high-risk locations were selected for photo speed enforcement:

- Circle Drive in Saskatoon
- Hwy 1 and 9th Ave. in Moose Jaw
- Ring Road in Regina
- Hwy 1 East between Pilot Butte and White City
- Hwy 12 at Martensville
- intersection of Hwy 41 and Hwy 2



For a current list of the locations visit www.sgi.sk.ca.



Stop sign ahead



Divided highway ends



Traffic signals ahead
Be prepared to stop



Railway ahead
Road intersects with rail tracks ahead at angle depicted



Road narrows
Road ahead is not as wide as the road you are driving on



Narrow bridge ahead
Width of pavement narrower than approach



Lane ends
Right lane ends



Winding road ahead
First curve right



Reverse curve ahead
Two turns in opposite directions separated by a tangent of less than 120 m, first turn right



Curve to the right ahead



Sharp curve to the right ahead



Maximum advised speed
Recommended safe speed

4.9 Warning signs



Underpass ahead
Overhead clearance
as shown



Concealed or
hidden intersection
ahead
Road from right
and/or left



Added lane
Two roads converge
and merging
movements are not
required



Two lanes
merge ahead
Traffic entering
from right



Checkerboard
Road ends



Pavement ends
Continuation has
gravel surface

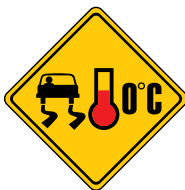

Surface subject
to icing
Bridge or roadway
surface may be
slippery at zero
degrees Celsius*,
slow down



Snowmobile
crossing ahead



Cattle crossing
ahead



Warns of
T-intersection
Road turns sharply
right and left



Playground ahead
When this sign has
a km/h tab mounted
underneath, it means
that this speed is to
be observed



Pedestrian
crosswalk or
corridor ahead



School bus stop ahead

Stop for bus with flashing lights



School crosswalk ahead



Chevron (arrowhead)

Posted in groups to guide drivers around sharp curves in the road



Slow moving vehicle

Mounted on the rear of vehicles that travel at speeds less than 40 km/h. It warns drivers approaching from behind to slow down.

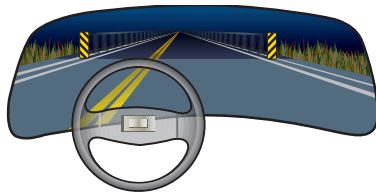

Hazard close to the edge of the road

The downward lines show the side on which you may safely pass



Warning sign on overdimension loads or on escort vehicles

4.10 Construction signs

Construction signs have black letters or symbols on an orange background.



Traffic control person ahead*
Be prepared to stop for instructions



Survey crew ahead*



Highway workers*

* The presence of one of the above three signs designates the start of the work zone. The Highway workers sign may or may not have a WORKERS PRESENT tab as illustrated.

In the work zone drivers must slow to the posted speed through the entire zone and 60 km/h or less when passing a worker, flag person or equipment occupied by a worker. Some cities have bylaws requiring drivers to obey work zone speed limits through the entire construction area. Please be familiar with the bylaws in your area.



Truck entrance left/right
The location at which trucks are entering, leaving or crossing



Be prepared to stop if you are driving a vehicle with a high load



Construction ahead
This sign indicates you are entering a construction zone. Drive with extra caution and be prepared for changes in the speed limit



Be prepared to stop



Pavement drop-off

This sign warns motorists that they are on or approaching a section of roadway where either the adjacent lane or shoulder or both are lower or higher than the motorist's travel lane

4.11 Railway crossings

Drivers should check for trains at every crossing, even those equipped with automatic signals. Always proceed with caution when crossing railway tracks.

Never get trapped on a crossing

When traffic is heavy, wait on the approach to a crossing until you're sure you can clear it.

When the last car of a train passes the crossing, do not start up until you're sure no train is coming on another track, especially from the other direction.

Never race a train

Racing a train to the crossing is foolhardy. You may lose.

Avoid shifting gears on a crossing

If your vehicle has a manual transmission, shift down before the crossing.

Watch for vehicles that must stop at crossings

Be prepared to stop when you are following buses, school buses or large trucks that are required to stop.

Automatic protected crossings

Never drive around gates

If the gates are down, don't cross the tracks until the gates are raised. It's against the law to go around crossing gates.

Flashing lights

At crossings without gates, you may cross the tracks, after stopping, while the red lights are flashing if it's safe to do so. However, if a train is closely approaching, or if a signal person signals you to stop, you must stop and wait until it's safe to proceed. Some railway crossings may have an advance flashing amber (yellow) light and sign warning of a train ahead at a concealed crossing.

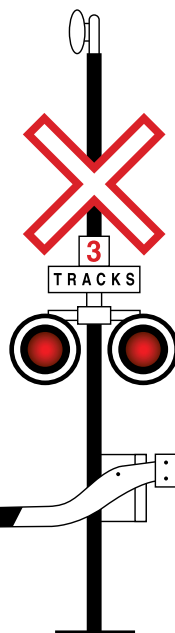
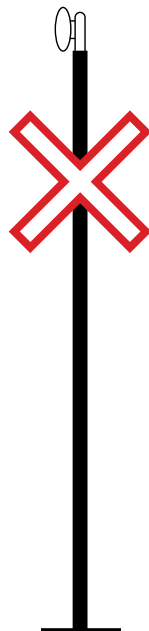

4.12 Crossroad delineators

Triangular reflective delineators can be found mounted on both sides of a sign post at many rural intersections controlled by stop or yield signs.

They alert rural drivers to the fact they're approaching an intersection and indicate the classification of the road as follows:

Three delineators

- all provincial and public highways
- community access roads
- grid roads
- major streets

Two delineators

- main farm access roads
- improved all weather roads
- intermediate urban streets

One delineator

- all other minor rural roads and local urban streets



4.13 Guide signs



Trans Canada
Highway



Provincial
Highway



Numbered Rural
Municipal Route
Marker



Airport
*Plane points
direction to airport*

4.14 Information signs



Advance
community sign
with service tabs



Telephone



Picnic facilities



Accommodation



Trailer facilities



Food



Swimming



Camping



Hospital



Golf course



Police



Museum

Gasoline fuel
Diesel fuel (D)

4.15 Traffic signals

A green light at an intersection means you may turn left, right or drive straight through the intersection, unless a sign prohibits any of these movements, once the intersection is clear and it's safe to do so.

If you want to turn left you can enter the intersection on a green light, but you must yield to oncoming traffic and pedestrians. If traffic is heavy, you may be forced to complete your turn on an amber (yellow) or red light.

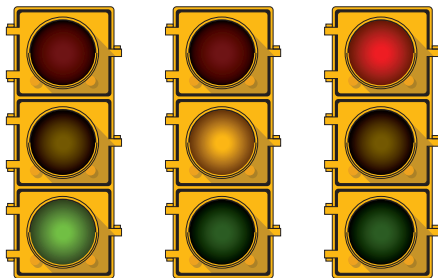

You can often predict the appearance of an amber (yellow) light by taking note of how long the light has been green and by watching for the “don't walk” light, especially if it is flashing.

When approaching an amber (yellow) light at an intersection, you must stop before entering the crosswalk. If you have already entered, or cannot stop safely, proceed with caution.

When approaching a red light, you must stop and remain stopped until the light changes. If you're making a right turn at an intersection, you may make the turn, but only after stopping and yielding the right of way to pedestrians and to any vehicles travelling through the intersection.

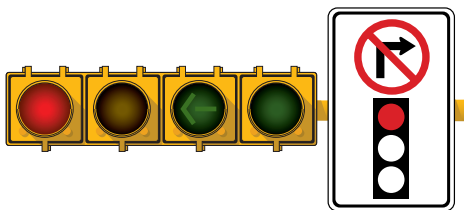

If you're in the outside (left) lane of a double right turning lane, you may also turn right after stopping and yielding the right of way to pedestrians and vehicles. Use extra caution, it's not a common manoeuvre.

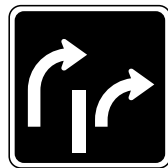

This also applies to making a left turn at the intersection of two one-way streets. Some intersections may have a sign prohibiting turns on red lights.

You may not make a U-turn at any intersection where there are traffic lights unless there is a sign to indicate U-turns are permitted.

When approaching a red light and a light with a solid green arrow, you may proceed in the direction of the arrow only after yielding the right of way to any other vehicles and pedestrians.

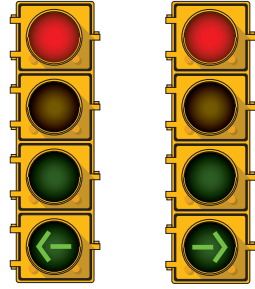

When approaching a red or green light and a flashing green (left turn) arrow, you may proceed in the direction of the green arrow.

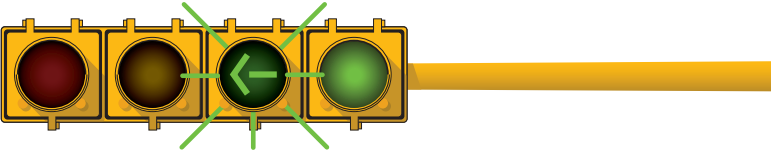

After the left turn arrow, an amber (yellow) arrow may appear. This means the green light is about to appear for traffic in both directions.

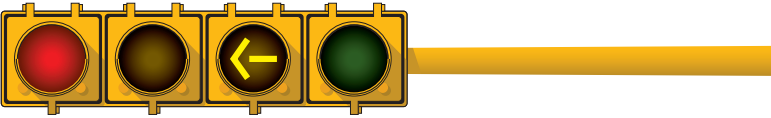

When approaching a flashing amber (yellow) light, you must proceed with caution. Alternating flashing amber (yellow) lights may warn you that traffic lights ahead are red or about to turn red.



When approaching an amber (yellow) light, you must yield the right of way to any pedestrians in the crosswalk or pedestrian corridor.

When approaching a flashing red light you must stop, but you may then proceed when it's safe.

Pedestrians may not cross an intersection when they are facing a red light, an amber (yellow) light or a "don't walk" light or symbol. A flashing "don't walk" means pedestrians should finish crossing the street if they have already started. Some signals have a countdown showing how many seconds remain before it is unsafe.

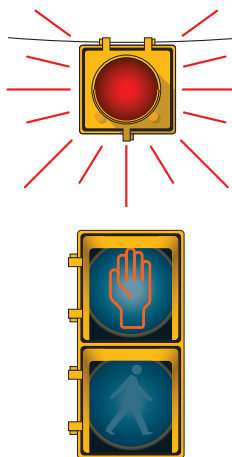

5. Basic driving skills

5.1 Hazards

A hazard is a source of danger. When driving, it's something that forces you to change your speed (usually to slow down) or change your steering (usually to steer around it) to avoid a collision.

Real and potential hazards

A real hazard is something that you have to react to. Examples of real hazards are: a stop light, a car moving slowly or stopping in your lane, a curve that requires you to slow down, a pedestrian or vehicle blocking you.



Real hazard

A potential hazard is something that might happen and you may have to react to: a car signalling the intention to change lanes, a car on the shoulder that might pull out, a pedestrian who might cross the road or a traffic light that might change.



Potential hazard

These two types of hazards will be referred to frequently in the following sections.

5.2 The IPDE method of driving

We use the IPDE (Identify, Predict, Decide, Execute) approach to driving to deal with potential and real hazards. IPDE defines the four steps involved.



Identify

The first step to good driving and avoiding collisions is to identify, well in advance, real and potential hazards.

From the thousands of objects in your field of vision, you must learn to filter out those that do not provide you with information relevant to the driving task. For instance, although a red neon sign attached to a restaurant may catch your eye, it's an unnecessary distraction because it's irrelevant to the driving task. You must search for real or potential hazards (such as traffic lights or children) and give them your immediate attention.

To use this information the hazard must be spotted in plenty of time. That's why your windows need to be clear.

Predict

Step two is to predict what will happen should you encounter a real or potential hazard.



Real hazards

For a real hazard, such as a red light, stop sign or a stopped vehicle, you simply predict whether or not the traffic light will change or the vehicle will remain stopped.

You usually see real hazards in plenty of time and will have few problems predicting what will happen. Although you may be scanning the road properly, a vehicle may suddenly stop right in front of you. You will then have to quickly predict what may happen in the next few seconds.

Potential hazard

Every vehicle you share the road with is a potential hazard. Be aware of where other drivers could go. Make your best prediction of what they're likely to do and keep revising this prediction as you move towards them. Pedestrians, cyclists or children on the side of the road are often potential hazards.

Predict the path of potential hazards. The vehicle may make a right turn. The child may run across the road.

The more often you practise predicting what may happen and what pedestrians and other drivers might do, the quicker you'll be able to make accurate predictions.

Decide

Step three is to decide exactly what you'll do to drive smoothly and deal with the hazard. This means planning your actions in detail and checking to see that the way is clear to proceed.

Real hazards

You may decide to simply brake gently or change lanes to avoid the hazard, or you may want to brake hard, release the brakes and steer.

Potential hazards

When you encounter a potential hazard, you may decide to take no action and continue to monitor the actions of other drivers, or you may decide to take action to avoid the other vehicles.

Consider the following steps before you take any action:

1. Check that your chosen gate is still open.
2. Check the surface condition of the roadway for braking.
3. Check the shoulder and the ditch.
4. Continue to watch the vehicle and decide whether you will take action to avoid it.



Execute

The final step, to execute, means to carry out your decision.

Executing some of your decisions will simply mean making a smooth stop at a traffic light.

Executing other decisions may involve using techniques for emergency driving.

To be good at executing your decisions, particularly emergency decisions, you need to practise in a safe situation, preferably with a trained instructor. Practice helps you overcome the panic that usually arises the first time you're in an emergency.

Practice makes perfect

When you begin practising the IPDE method you'll be slow and will probably think in words. As you practise, you'll become faster and begin to think in ideas and pictures. At this stage, you will be able to carry out the entire procedure rapidly. You can cut your reaction time by taking the time to practise the IPDE method. It may save your life.

Once you have been using IPDE for some time, much of your identifying, predicting, deciding and executing will be carried out instinctively.

You'll need to use IPDE more often in heavier traffic and when you are driving at higher speeds.

You'll find that your physical condition greatly affects your ability to handle IPDE. If you're tired or ill, you should reduce the IPDE load by travelling at reduced speeds. You can reduce the IPDE load by avoiding heavy traffic. You might also consider not driving.

Alcohol and other drugs make it very difficult to carry out the IPDE process. Since IPDE is designed to prevent you from having collisions, it's not surprising that a large number of crashes are alcohol-and drug-related.

5.3 Time – the key to judgment

It's difficult to judge how far things are ahead of you. It's even more difficult when both your vehicle and the object outside the vehicle are moving. For example, can you judge how far away an approaching car is?

We all have internal clocks. We all have an internal awareness of time. Why not use time to measure how far ahead things are in day-to-day driving? You can do this by counting seconds.

To count time in seconds, say out loud, "thou - sand and one, thou - sand and two, thou - sand and three," at a normal speaking rate without pausing between the numbers. This will give you a reasonably accurate count of three seconds.

Practise checking against your watch; you'll be counting off perfect seconds in no time.

The language of time

The most important skill in driving is being able to use your eyes effectively to seek out the information you need to drive. To use time as the basis for all of your driving, with special emphasis on your eye use, you need to understand the different ways of estimating time.

First, you must be able to estimate, while you are driving, how far stationary objects or fixed distances are from you. For example, the sign is nine seconds away and at 100 km/h the spaces on the broken lines on the highway disappear about 12 seconds ahead.

Estimate distance ahead in the following way:

1. Pick a stationary object that is on or near the road (for example: a sign, shadow, overpass or pavement patch).
2. Guess how many seconds the object is ahead.
3. Then start counting “thou - sand and one, thou - sand and two, thou - sand and three,” etc.
4. When your front bumper is beside the object, stop counting. This will give you the number of seconds between you and the object chosen. If you guessed 15 seconds and the distance ahead is really eight seconds, then guess a lower number next time. Try for longer distance; see if you can guess how far away 40 seconds is. This way you'll improve your judgment.
5. Continue practising this exercise until you can judge time accurately.

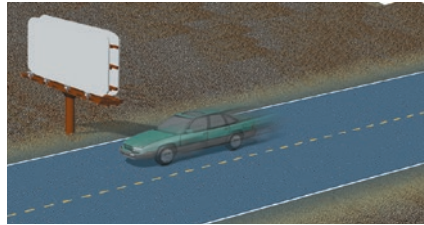
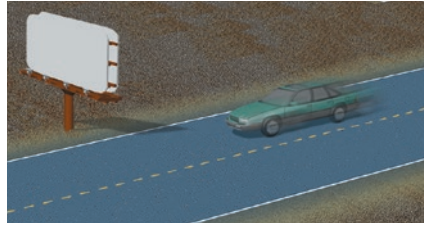
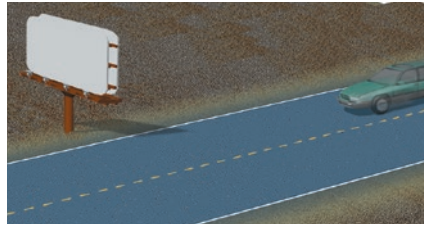

The relationship between time and distance varies with speed. Therefore, begin by making all your judgments at the same speed. Then, practise at other speeds at which you most commonly drive, say 100, 80 and 50 km/h.

Using time to estimate your following distance

When you are driving, estimate the distance between you and the vehicle in front in the following way:

1. Pick something that is on or near the road and is not moving (for example, a sign, pavement patch, shadow or overpass).
2. When the back bumper of the vehicle ahead is even with the object you have chosen, start counting – “thou - sand and one, thou - sand and two, thou - sand and three,” etc.
3. When your front bumper is beside the object, stop counting. This will give you the number of seconds between you and the vehicle you are following.
4. If you are closer than three seconds, drop back and check again until you have achieved a minimum of three-seconds following distance. Any following distance longer than that is safe. However, a longer following distance is recommended when following a motorcycle.

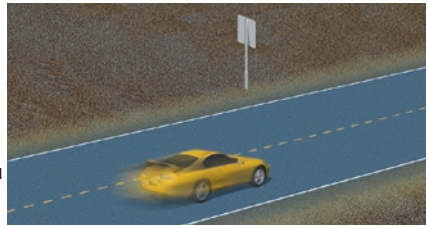

You will notice that by keeping a three-second following distance, regardless of your speed, the distance between you and the vehicle in front will automatically lengthen as you go faster. So, for a three-second following distance at 100 km/h, you will be twice as far back as you would be at 50 km/h and four times as far back as you would be at 25 km/h.

Time – distance relationships

Speed		Metres/second	3-Second Following Distance (in metres)	12-Second Following Distance (in metres)
km/h	MPH			
100	62	28	84	336
90	56	25	75	300
80	50	22	66	264
70	43	19	57	228
60	37	17	51	204
50	31	14	42	168
40	25	11	33	132

For a three-second following distance at 100 km/h, you will be twice as far back as you would be at 50 km/h.



There is one situation where a three-second following distance is not enough. If you are following a large truck or van that blocks your view of traffic ahead, drop back to more than three seconds until you can see around the vehicle.



 *Incorrect*



 *Correct*

You may feel that if you try to keep a three-second following distance, other drivers will cut into the space you leave. This will happen sometimes, but less often than you think. To give up your sight distance, your planning and response time and relaxed driving just because you want to save a few seconds and not let other drivers cut in, is a poor bargain. If you let other drivers dictate your driving style, then you're not in control.

5.3 Time – the key to judgment

The three-second following distance is recommended when driving conditions are ideal. If driving conditions are less than ideal, your following distance should increase accordingly.

To understand why, you will need to examine how three seconds would be spent in a situation that could turn into a collision.

First, you'll spend some of the three seconds identifying the problem, predicting the outcome and deciding what to do, through the IPDE approach to driving. Then you need some reaction time – to get your foot off the accelerator and apply the brake. If you're reasonably alert, you can do all of this in three seconds and begin braking, too.

If you stop at the same rate as the vehicle ahead, you'll not hit it.

But, if the driver in front hits a fixed object; you're tired and are slower to react than the other driver; the other vehicle has better traction; or, the other driver is more skilled at braking than you are, then you need more than three seconds to avoid a collision.

However, if you're looking ahead as far as you should, you'll see the cause of the problem any time from 12 to 60 seconds ahead – possibly before the driver ahead of you sees it. In this case, you can respond to the problem rather than to the brake lights of the vehicle in front of you.

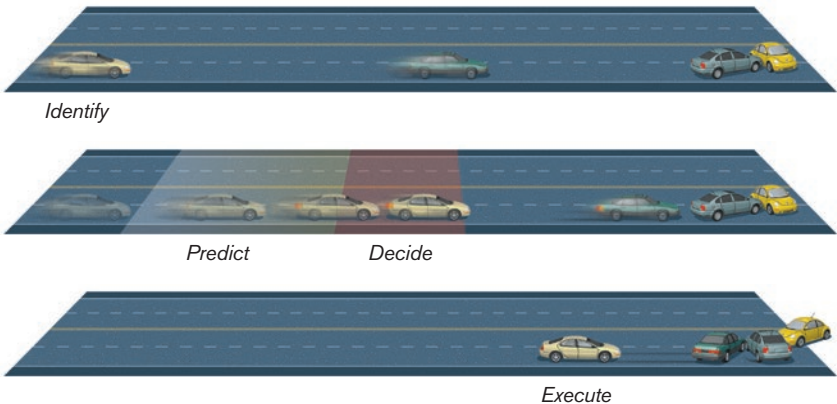

5.4 Eye use

Of all your senses, your eyesight is the most important for driving. Your eyes pick up most of the information you need to drive.

Steer where you look

It's important to understand that your eyes determine the path your vehicle follows – **you steer where you look**.

To illustrate this, pick a straight stretch of paved highway with light traffic. While driving, look at the centre line about 12 seconds ahead. Keep looking at the centre line 12 seconds ahead. Observe how the car moves toward the centre line.

Now, look at the edge of the road 12 seconds ahead.

You will steer where you look.

To steer straight ahead, look about 12 seconds directly ahead of where you are sitting.

To steer around a curve, look at the inside of the curve to where the centre lines vanish. Do not look in the mirrors, don't look down at your instrument panel. If you take your eyes off the road, you will not maintain precise control over your steering.

Remember, if you look at the side of the road, you'll steer to the side of the road. Look where you want to go, particularly in an emergency or a skid, and steer there.

Check your mirrors and speed when you're driving in a straight line, and when steering is less critical.



Search patterns on highways and rural roads

When you drive on a highway, you hope the road is clear and unobstructed. To verify that, you'll need to perform a search pattern – searching the road for any obstructions or hazards.

Looking up on highways

As part of your search pattern, look up as far as you can see. To look up means to look as far ahead as you can see the highway – to the horizon (on a straight road, you may be able to see up to 90 seconds ahead).

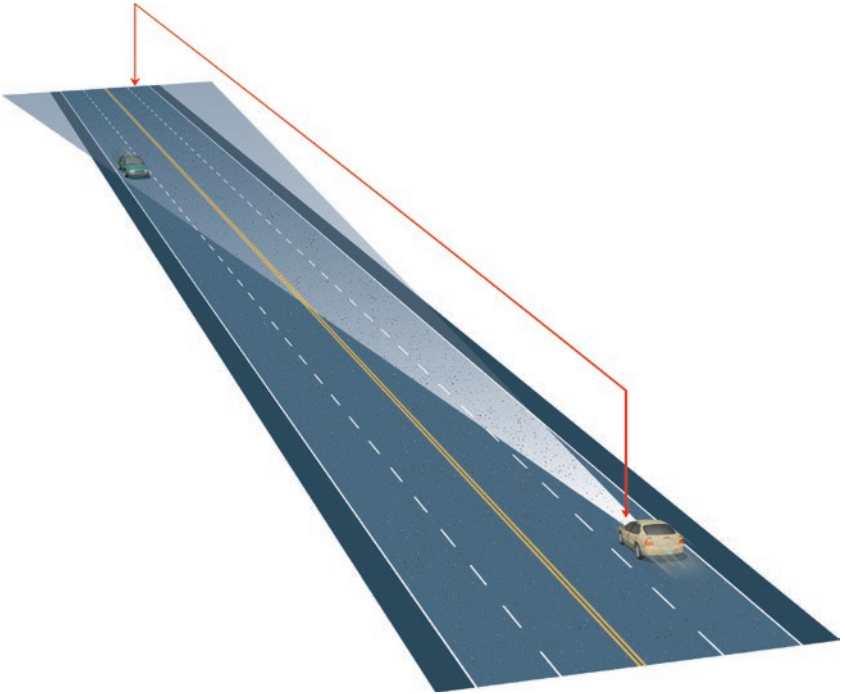

On a curve, look up across and around as far ahead as you can see. At first, you'll likely have to concentrate to look this far ahead in curves.

When curving right, look at the shoulder line to the point where it disappears. Keep looking at that point and maintain a steady speed. When curving left, look at the centre line as far as you can see it. When coming out of the curve, look at your lane all the way to the horizon.

As you develop that "far ahead" view, you'll automatically drive the curve smoothly and accurately. You'll also benefit from seeing your path far enough ahead to deal with any obstacles in your path.

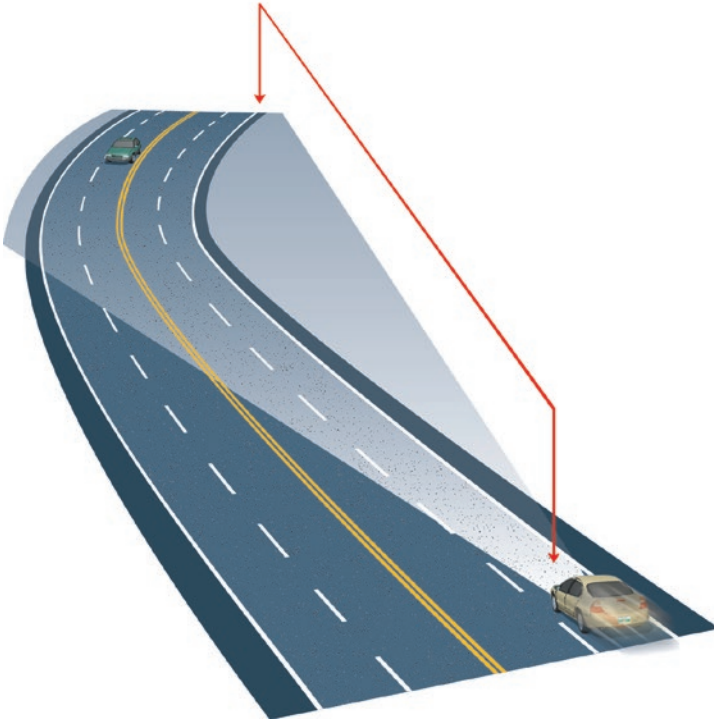

Referencing down on highways

Reference down by moving your eyes down from the look up position so that you see the road 12 seconds ahead at 100 km/h.

Look on the road in front of you to where the spaces on the broken lines on the road disappear. This will be about 12 seconds away. This will help you obtain information you require to steer accurately and safely.

Until now, you have been looking up (to the horizon), referencing down (12 seconds ahead), looking up, referencing down, etc.

When most people try this exercise, they usually find that they have not been looking up as far as they can see. Also, they have usually been referencing down much closer than 12 seconds.

To establish search patterns of up to 90 seconds ahead and to stretch your referencing down to 12 seconds requires two things. First, most drivers must admit that they haven't been looking far enough ahead. Second, you have to practise to make looking up and referencing down a habit.

As you establish the habit of looking up and referencing down, you'll see the benefits to your driving, and this method will become easier every day. Also, steering where you look will help you overcome steering problems such as wandering within a lane or wandering from lane to lane.

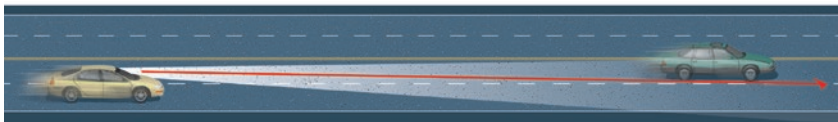

Sweeping highways with your eyes

The next part of your search pattern is to look for things that will interfere with your path – vehicles entering from the side, animals or people on the side of the road, or approach roads. This involves sweeping your eyes across and to the side of the road. Try to sweep about 12 seconds ahead.

Filling in the gap on highways

Now fill in the gap between you and where you reference down 12 seconds ahead. Check the vehicles in front, the road surface for ice or pot holes, and the width and firmness of the shoulders.

Checking your gates on highways

Next, you need to check which gates are still open; that is, the space around your vehicle on all four sides. Pay close attention if you have detected a real or potential hazard. Check your mirrors often to see whether the rear and two side gates are open.

Checking your instruments on highways

You should check your instruments when it's safe to take your eyes off the road. Even checking your speed takes one and a half seconds. Therefore, check your instruments when you're on a straight stretch of road with your gates open and with no real or potential hazards ahead.

Check your speed and, less often, glance at your gas gauge and other instruments or warning lights.



Now your pattern should be: look up, reference down, look up, reference down, sweep left, sweep right, look up, reference down, fill in the gap, look up, reference down, check your gates, look up, reference down, check instruments, etc.

The exact sequence that you use will vary with the features and the traffic on the highway. The most important part of the sequence is to look up and reference down. Include the others as needed. The more often the situation changes around you, the more often you have to search.

Search patterns in urban areas

The pattern for city driving is similar to that of highway driving. It's not easy to achieve, but is worth practising.

Looking up in urban areas

To look up in an urban area, look ahead as far as you can see – usually several traffic lights or a number of blocks ahead. This will give you information about the flow of traffic, the sequence of the lights and whether there is construction or major obstructions ahead.

Referencing down in urban areas

Next in the sequence, you should reference down. To reference down in an urban area, move your eyes down from the look up position so that you view the road 12 seconds ahead at city speeds. Even if you cannot see clearly for that distance, you should look around or through the windows of the vehicles ahead. Try to see cars well ahead that are slowing down, changing lanes, turning or stopping. Watch for brake and signal lights.

Sweeping with your eyes in urban areas

In the city you need to sweep further to each side and sweep more frequently than you do on the highway.

The sequence now should be: look up, reference down, look up, reference down, sweep left, sweep right, look up, reference down, etc.

Filling in the gap in urban areas

You need to fill in the gap between you and where you reference down, 12 seconds ahead. In the city, you need to do this more often than on the highway because you do not have as clear a view ahead.

Checking your gates in urban areas

You need to be more aware of the status of your gates when driving in the city because vehicles are more likely to be in your blind spot.

Never permit yourself to drive in a situation where there are fewer than two gates open. If you cannot control the rear and side gates, at least you can drop back and double the distance between you and the vehicle ahead – to five or six seconds.

Checking your instruments in urban areas

You'll have little time to check your instruments when driving in the city. From time to time, check your speed. But remember to do this in light traffic or on straight, unobstructed roads. You can check your gauges at traffic lights and stop signs.

Search patterns at night

At night, your search pattern is much the same as it is during the day. You should look up and reference down to about 12 seconds ahead. This means that most of the time you'll be looking **beyond** the part of the road illuminated by your lights.

You still need to sweep with your eyes, fill in the gap and check your gates and instruments.

Do not look at the side of the road because you will steer there. Obviously, don't look at oncoming headlights because the glare will blind you. Look 12 seconds ahead, directly in line with where you are sitting.

Search patterns in emergencies

The rule for where to look in emergencies is simple: **look where you want to go and steer there.**

If you are sliding or skidding sideways, don't look down, don't look at the instrument panel and don't look at what you might hit. Look where you want to go.

Preventing potential collisions

Most collisions occur at intersections and cross roads. To help you spot and prevent a potential collision, use the following method.

Scenario:

You're driving on a road towards an intersection and spot another vehicle approaching the same intersection. You don't know how fast the other vehicle is travelling or how far away it is from the intersection. To help you determine if a collision is imminent, maintain your speed and course, and turn your head to take note of the other vehicle's position in relation to you. Continue to maintain your speed and course for a few seconds and check the other vehicle's position again by turning your head. If the other vehicle is still at the same position, you're on a collision course. Start slowing down, and be prepared to yield or stop to avoid a collision.

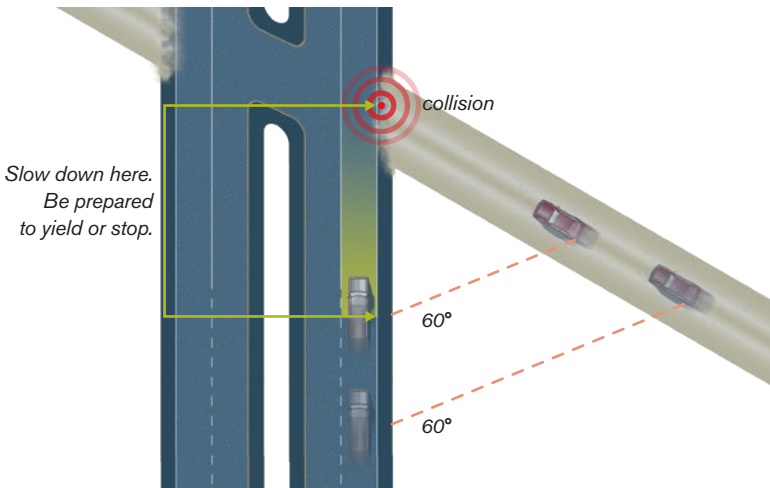

It's important to turn your head while looking for approaching vehicles and not rely on your peripheral vision only. Peripheral vision is very good at picking out objects that are moving; however, in the above scenario the other vehicle would appear to be not moving as it's in a fixed position in your peripheral view.

Driving in dense traffic

If you're not accustomed to driving in dense traffic, the experience can be highly stressful. You can make it easier if you plan where you wish to go in advance. It's nerve wracking to drive in a new environment and to try to navigate at the same time.

The most important thing to remember is don't give up your following distance. Don't stop your search pattern. If the drivers around you are driving one second apart, let them, but don't be tempted to follow their example.



5.5 Before you drive

Vehicle familiarization

Many drivers have collisions during their first week of owning a new car because they don't know where the controls are.

Whenever you get into a vehicle that is new to you, take time to find out where the controls are. You must be able to operate the windshield wipers, windshield washers, horn, lights, heater, radio, turn signals and hazard lights without looking at them. With the vehicle stationary, practise looking at the road ahead while you reach and adjust each control.

Read the owner's manual. New vehicles have new design features that you should be familiar with if you're to drive safely and get maximum enjoyment and efficiency from your vehicle's equipment. Visit mycardoeswhat.org to learn more about how to use safety technology and features such as back-up cameras, lane departure alerts, and blind spot detection.

Before you drive check that:

- doors are properly closed (if security is an issue, you may want to lock your doors)
- all loose objects are secured
- your seat is properly adjusted
- head restraints are properly adjusted
- mirrors are properly adjusted
- air flow regulators are adjusted (vents, heaters, air conditioning)
- seatbelts are fastened and properly adjusted
- bulbs in warning lights are working and the lights go out when the engine starts (see owner's manual)

Should an engine or oil warning light come on while operating your vehicle, the cause should be determined as soon as safely possible. Continuing to drive with a warning light on may cause damage to the vehicle.

Design components for safety

Vehicle designers must prevent injury and reduce the seriousness of injury in crashes by building safety features into the design of every vehicle.

Important safety features include head restraints, seatbelts and airbags.

Head restraints

In some vehicles, the head restraints are built into the seat, while in others you have to adjust them.

If your vehicle is hit from behind, or if you hit someone in front, you are much less likely to suffer a whiplash injury to your neck if your head restraint is properly adjusted.

Adjust the height of the head restraint for each driver or passenger. The protection afforded is well worth the effort.

Adjust the pad of the restraint to support the back of your head. The top of your head restraint should never be lower than the top of your head.

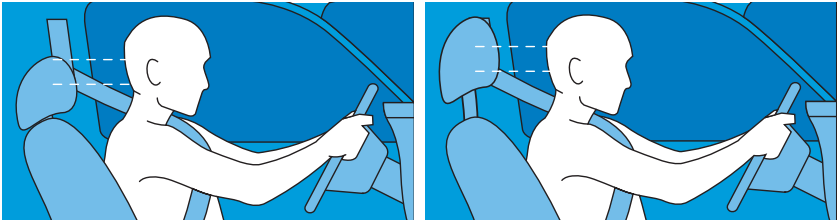

 *Incorrect*

 *Correct*

Seatbelts

A safe passenger compartment is an important part of vehicle design. The front and rear of a car are designed to collapse on impact while the passenger compartment remains undisturbed. Your chances of survival are, therefore, greatly increased if you remain in the passenger compartment.

Your seatbelt will keep you in your seat and will reduce the forces your body experiences in a crash.

In Saskatchewan, every vehicle occupant must wear a seatbelt where they are provided in a properly adjusted and securely fastened manner. Obey the law and increase your chances of surviving a collision. Put on your seatbelt every time you ride in a vehicle. To be most effective, seatbelts must be used properly. First, put the lap belt on, adjusting it to fit over your pelvis, and pull it snug. The lap belt is designed to take the force on your pelvis – not your stomach. Keep the lap portion low.

Next, adjust the shoulder portion of the seatbelt over your chest area. How you do this will vary from vehicle to vehicle. Some adjust automatically, others work like a window blind. Adjust your shoulder belt to make it snug, yet comfortable. Shoulder belts should never be worn behind your back or under your arm.

5.5 Before you drive

*Lap belt**Shoulder belt*

Drivers are legally responsible to ensure that passengers under 16 years of age use seatbelts where available and child safety seats, when appropriate. If not, the driver may be charged. Passengers aged 16 years and older are responsible for buckling themselves up.

Being a safety-minded driver means you make sure everyone in your vehicle is properly secured. Without a seatbelt or proper child safety seat a passenger can become a dangerous flying object during a collision.

Child restraints

In collisions, children can acquire severe injuries by being thrown about or completely out of the passenger compartment. This can happen more easily than with adults because they have heavy heads in relation to the rest of their bodies. Their necks and bodies are not strong enough to withstand the impact of a collision or sudden braking.



In Saskatchewan, small children must be properly fitted into approved child restraints that are correctly installed. Children who weigh less than 18 kg (40 lb.) must be buckled into proper child safety restraints that are fastened to the vehicle by a seatbelt and any other straps specified by the manufacturer no matter who is transporting them – parent, grandparent, caregiver.

Children under seven years of age, weigh less than 36 kg (80 lb.), and are less than 145 cm (4'9") must be properly fitted into an approved booster seat, used according to manufacturers' instructions.

For more information on child restraints, refer to our Keep Them Safe brochure, visit www.sgi.sk.ca or contact SGI Traffic Safety Promotion at 306-775-6042 or 1-844-TLK-2SGI (1-844-855-2744) or email trafficsafety@sgi.sk.ca.

Airbags

Almost all vehicles are equipped with air bags. The tough fabric bags inflate in crashes over 16 km/h, cushioning an occupant's neck, head and chest in moderate to severe impact.

Children should never be put in the front seat of cars equipped with passenger-side airbags. The force of an airbag deploying is enough to critically injure or kill an infant or small child.



Airbags are not a replacement for seatbelts. Seatbelts alone provide all the protection a person needs in low and moderate-speed impacts. Airbags are most effective in high-speed crashes, where they often prevent serious injury.

Driver-side and passenger-side airbags are common features in newer automobiles. Airbags are also installed in the doors of some cars to prevent passengers from hitting their heads against the windows or pillars of the car during a collision.

Occupants must wear seatbelts to protect themselves in these circumstances and to ensure that in the event of a frontal crash, they remain in the seating position necessary for airbags to be effective.

5.5 Before you drive

Seating position

If you don't sit properly, you cannot steer well nor can you use your brake or accelerator efficiently.

The proper way to sit:



1. Sit up straight and well back into the seat. Your body should be firmly against the seat back and cushion.



2. Move the seat forward or backward so your right foot is placed on the floor underneath the brake. The seat should be sufficiently forward so that your right leg cannot be straightened, and remains slightly bent even when you push hard.



With a manual transmission, depress the clutch with your left foot. When it is all the way down, your leg should still be slightly bent.

If, with the seat adjusted as far forward as it will go, you are too far back to be in this position, pad your back with cushions.

3. If the seat height can be changed, adjust it so you can see over the steering wheel, preferably so that your line of vision is half way between the top of the steering wheel and the top of the windshield. If necessary, use a cushion to raise yourself to the correct height. Try also to have at least a fist's space between the top of your head and the roof of the vehicle.

The angle of the seat should be adjusted to support your thigh, but you should not have to use excessive force to depress any pedal to the floor.



4. Adjust your seat so that your arms are slightly bent when you reach out and grasp the steering wheel in a "9 and 3" or "8 and 4" position (see "Steering," page 101).



5. Adjust the head restraint so that the top edge is level with the top of your head.

Mirror adjustment

Proper mirror adjustment is critical to safe driving. The following page outlines an excellent method to adjust your vehicle's mirrors to maximize your view of the road. Remember, always adjust your mirrors before you start to drive.

Begin with the rear-view mirror. Adjust the mirror so that you're able to see as much of the rear window as possible. While adjusting the mirror, aim to keep your head in the same position as it will be when you are actually driving your vehicle.

Adjusting your side mirror is a little more difficult. First, lean to the left so that your forehead is barely touching the side window. Then move the mirror so you can just see the left side of your vehicle.

To adjust the right side mirror, position your head toward the centre of your vehicle. Adjust the mirror so it shows just a sliver of the right side of your vehicle.

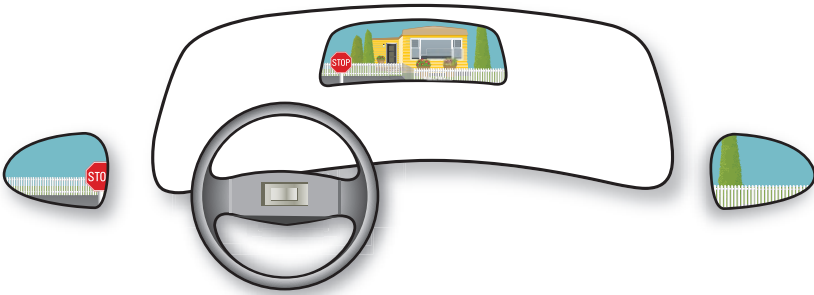

By setting mirrors so the driver can see both sides of the vehicle from the driving position, the same image will appear in all three mirrors. By setting them so the driver has to lean to see the sides of the car, the outside mirrors continue on where the inside mirror leaves off – significantly reducing the blind spot.

Another advantage of positioning your mirrors this way is that it reduces headlight glare from vehicles travelling behind you.

Left foot brace

The left foot brace refers to the bracing of your left foot against the fire wall (located below and behind the pedals separating the engine from the driving compartment) to support you and to keep you firmly in your seat.

Place your left foot against the fire wall and push whenever you need stability such as when negotiating a curve, when braking, in an emergency or on slippery pavement.



Bracing with your left foot helps you steer easily and well because you are not leaning on the wheel. Also, if you're not supporting your weight on the heel of your right foot, it is free to brake and accelerate with greater precision and control.

The fact that you need a left foot brace for controlled driving means you cannot use your left foot to brake. Always brake with your right foot.

5.6 Steering

Hand positions

There are two correct hand positions on a steering wheel: "9 and 3" and "8 and 4."



"9 and 3"



"8 and 4"

These methods refer to visualizing the steering wheel as the face of a clock, and positioning the left hand at the 9 or 8 and the right hand at the 3 or 4 o'clock position. Steering wheels and shoulder widths differ, so exactly where people grasp the wheel will vary.

On a vehicle equipped with an airbag in the steering wheel, a hand placed on the top of the wheel may be forced back into the driver's face if the airbag is deployed, causing injury.

Once your hands are in correct position, don't shuffle them around on the wheel. Keep your grip in the same place and simply twist the steering wheel to turn the vehicle.

You can twist the wheel until your forearms touch. To steer beyond this point, you'll have to use a "hand over hand" or "hand to hand" steering sequence.

The key to steering is to know the steering wheel position at which your front wheels are straight. When you start out, straighten your front wheels and place your hands in position. Provided that you don't shift your grip, every time your hands are straight and level, you know your front wheels are straight.

“Hand over hand”

This method is used when turning the wheel sharply either when driving slowly or in emergencies when conditions are very slippery.

As you turn the wheel, pull the wheel down with the top hand, take the bottom hand and put it up at the top, pull the wheel down with the top hand, take the bottom hand and put it at the top, etc.

When unwinding the wheel after a turn, use the hand over hand system. Don't let the wheel slide through your hands – you have very little control of the speed at which it comes back or the point at which it stops.



“Hand-to-hand”

Commonly called push/pull steering or zone steering, when using the hand-to-hand steering method, your left hand grasps the wheel between 7 and 8 o'clock, and your right hand between 4 and 5 o'clock. Depending on the direction you turn, your right or left hand pushes the wheel up and the opposite hand slides up, grasps the wheel and pulls down to turn.

While the pulling hand moves down, the hand that initially pushed up slides back toward its original position to make adjustments as needed. The driver should use the area on the wheel between 11 and 8 o'clock with the left hand and the area on the wheel between 1 and 8 o'clock with the right hand regardless of the direction of the turn.

Simply reverse the process to bring the vehicle back to the desired path. Since your hands never cross over the steering wheel, there is less chance of an injury to the face, hands or arms induced by your hands or arms in the event of a frontal crash due to an air bag.

5.7 Accelerating

To move the vehicle smoothly and to save on fuel, push the accelerator down gradually and wait for the vehicle to build up speed.

In vehicles with automatic transmissions, the gears will change automatically for you. With manual transmissions, you have to release the accelerator and re-apply accelerator pressure as part of your gear shift.

To drive with precision, you must vary the accelerator position smoothly by small amounts.

5.8 Standard (manual) transmission vehicles

Driving a vehicle with a standard (manual) transmission requires significant practice and skill. Drivers should read the vehicle owner's manual for information specific to their vehicle.

Neutral/clutch

- know your gear pattern so you are able to shift gears without looking at the gear shift
- take the engine's rpm (revolutions per minute), choice of gear and road speed into consideration when shifting gears
- shift gears in order (e.g., 2 to 3 to 4, or 4 to 3 to 2)
- never force a gear
- never coast in neutral
- never depress the clutch (riding the clutch) for extended periods of time. The clutch should only be used when starting and stopping the vehicle, and to change gears.
- become familiar with accelerator and clutch timing. Poor timing from one to the other can cause the vehicle to jolt, jump or stall.

You should shift to neutral (or declutch) during emergencies or when stopping in winter driving conditions. This gives you better control over your vehicle by disconnecting the engine from the drive wheels. If you're stopping on a slippery surface and are in neutral, then your drive wheels are not driving the car forward while you are trying to stop. You stop more easily over a shorter distance.

To shift to neutral, declutch by pushing the clutch to the floor and hold it there, and move the gear shift lever to neutral.

When parking a vehicle, ensure the vehicle is in (first) gear, not in neutral, before leaving the vehicle. This is to prevent the vehicle from freely moving forward or backward while parked.

Standard (manual) transmission training is available from certain SGI certified driver educators.

Use the Driver Educator locator at www.sgi.sk.ca/drivereducator for a list of SGI certified driver educators.

5.9 Automatic transmission vehicles

Most vehicles on the road are equipped with automatic transmissions. An automatic transmission placed in drive “D” is designed to change gears automatically without any driver assistance. This type of transmission selects the most efficient gear based on speed and acceleration.

It's possible for the driver to make an automatic transmission shift by simply using the accelerator pedal:

To shift to a higher gear - ease up slightly on the accelerator.

To shift to a lower gear - push the accelerator to the floor. This technique is used for passing or to get out of an emergency situation quickly.

When driving down a steep hill, you can slow your vehicle by manually shifting to a lower gear and using engine compression as a braking effect. Simply move the gear shift lever from the drive “D” position to the next lower gear (usually third or second gear). It is recommended to make your gear selection at the top of the hill before you start going down. If you have to make the shift while driving down the hill, release the accelerator and use your brake to slow the vehicle down before moving the shift lever. To avoid engine damage, pay attention to ensure that the rpm's stay out of the red zone as you shift to a lower gear. You should use the brakes only as needed. Holding the brake pedal for an extended length of time may cause the brakes to overheat, which can result in a loss of braking ability.

5.10 Low speed skills

Surprisingly, certain low speed skills can be quite tricky. You need to drive slowly to park, turn sharply, back up or move forward in traffic jams.

Low speed manoeuvring

To drive slowly in an automatic-transmission vehicle, rest your foot on the brake and let the idling speed of the engine move the vehicle, braking as necessary to control the speed.

In a manual-transmission vehicle, you control very low speeds almost entirely with the clutch. Accelerate as for a normal start and hold your engine speed constant. Raise the clutch to the point at which the engine engages with the drive wheels, and stop. Then, ease the clutch up a small amount to move the vehicle. To gain speed, ease the clutch up a little more. To slow the vehicle, push the clutch down a small amount until the engine is again disengaged from the drive wheels.

If the vehicle is on a slope and/or is moving faster than you wish, declutch and brake gently.

Backing

You might think that being good at backing isn't very important. However, collisions while backing are among the most frequent type of collision. This is due, in part, to drivers who believe that a low-speed activity such as backing is no problem.

Never back a vehicle until you have checked behind it from outside. Children, bicycles, wagons, etc., aren't always visible from inside your vehicle.



Begin, as you should for all backing manoeuvres, with the vehicle straight and the front wheels straight.

1. From your normal seating position, shift your weight so that you're resting on your right hip.
2. Support yourself by placing your right arm along the arm rest or the top of the front passenger seat.
3. Grasp the top centre (12 o'clock position) of the steering wheel with your left hand.
4. While looking back, begin backing slowly. Within the first foot or so of vehicle movement, check forward. If the front of the vehicle is moving straight back, your front wheels are straight. If the front of the vehicle swings to the left or right, your wheels are not straight.

If the front of your vehicle swings to the left, turn your steering wheel to the left to straighten. If the front swings to the right, turn your steering wheel to the right to straighten. Once you get the wheels straight, move your grip to the new 12 o'clock position.

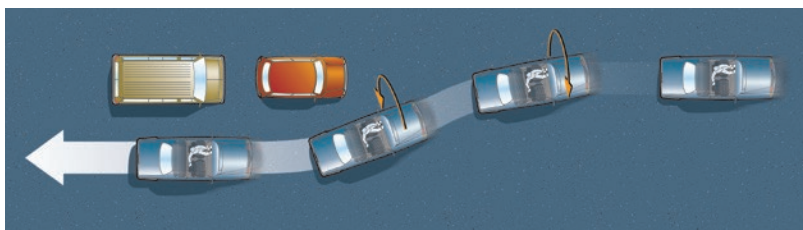

5. Having done this, you know that every time your hand is at 12 o'clock, your front wheels are straight.
6. Now, look through the rear window and focus your eyes well back along the path you want to go.
7. Move the vehicle slowly backwards. Look and steer where you want to go.
8. You'll notice that the vehicle turns much more when you are backing because the front wheels are pivoting, or swinging, around the rear wheels. This is called 'front end swing' and is the cause of many backing collisions.

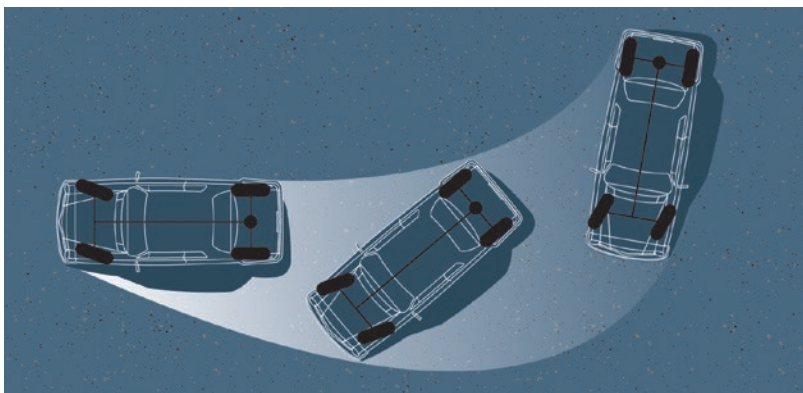

Steering techniques for backing

1. Hand over hand and hand-to-hand

Shift your weight slightly onto your right hip, grasp the steering wheel with both hands and use the hand over hand method to turn the steering wheel. While this method provides good steering control, it limits your ability to see out the back window. For the hand-to-hand method, refer to "5.6 Steering".

2. Palming (precision backing technique)

Palming is an advanced steering technique that's **only used when backing**. It's used in situations where both straight line backing and sharp turning are required. This method allows you to turn the wheel sharply while ensuring that your front wheels will be straight when your hand is at 12 o'clock.

Put your left hand at the 12 o'clock position but do not grasp the wheel. Instead, push your palm against the rim of the wheel with enough pressure so that when you move your hand down and around, the wheel turns, but your palm stays on the same place on the wheel rim.



6. Advanced driving skills

6.1 Parking

Parallel parking

First, find a space that you can fit your vehicle into. Signal your intention to park to other drivers as you approach. If you're not sure, stop your vehicle beside the space and check that you have **at least 2 m** more than the length of your vehicle. Shift to reverse as soon as possible to activate the back-up lights.

This is only one suggested method of parallel parking. There are others that work just as well.

1. Position your vehicle parallel to the front vehicle about .5 m out from it, with your back bumper lined up with the front vehicle's back bumper. Shift to reverse, check that the way is clear and get ready to steer.

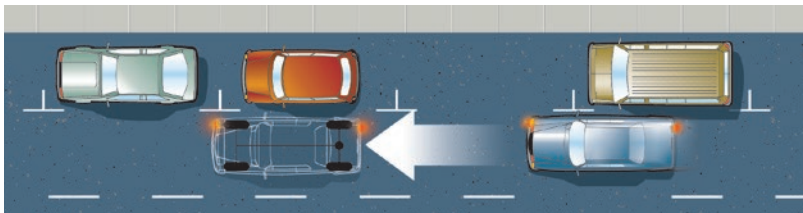

2. Back **slowly**. Immediately start turning your wheel toward the curb until you reach about a 45 degree angle. (Pay attention to your vehicle's front end swing into traffic. Make sure you are clear of oncoming vehicles.)

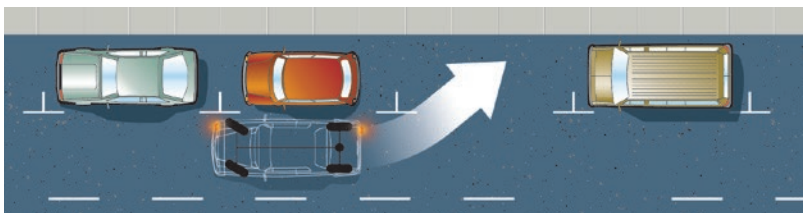

3. Continue to back slowly and straighten your wheels.

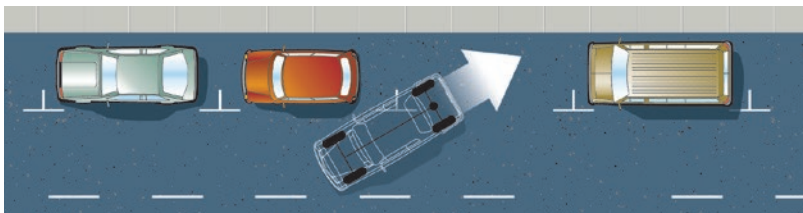

- When your front bumper clears the bumper of the front vehicle, continue to move slowly and turn your wheels away from the curb.

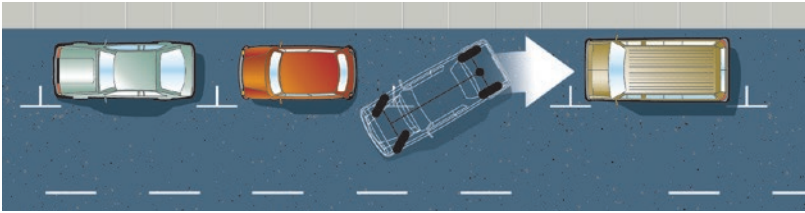

- If necessary, shift to first or drive, and slowly move forward while you straighten your vehicle.

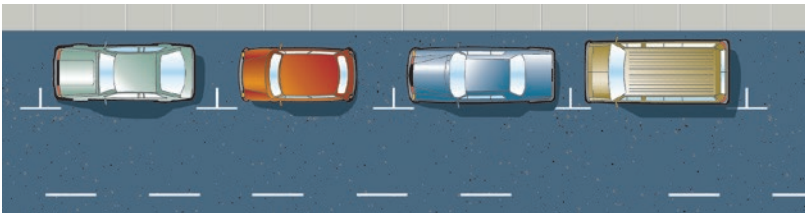
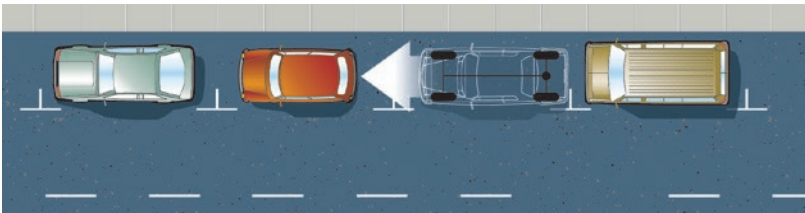

Back-up cameras

Driving assist options are becoming increasingly more standard on new vehicles. However, they aren't substitutes for proper driving techniques. In the case of back-up cameras, the sun can interfere with the view as can snow, or dirt. Before reversing, look over your shoulder and use your mirrors to check behind you. Shift into reverse to activate the back-up camera. As you back up, check the monitor for objects while being aware of your surroundings. Observe your mirrors and check or look through the rear window. Don't rely primarily on the monitor when backing.

Angle parking

Where a parking space is at 90 degrees (a right angle) to the road, as it is in most parking lots, it's recommended that you back into the space, unless prohibited. You have the advantage of being able to back in accurately because your windows are clear and you are warmed up for driving. In addition, the front end swing occurs in the aisle, not between two parked cars and you're backing into a space you know is free of obstacles instead of backing into traffic. More importantly, when you drive out you will have an excellent view.



Some parking spaces are at about a 60 degree angle to the road. These spaces are usually located in small urban centres and on one-way streets. You're meant to drive into and back out of them.



Steps in angle parking:

1. Signal your intention to park and slow down.
2. Check for approaching traffic from the front and rear.
3. Approach the stall approximately one vehicle width from the parked vehicles.
4. When your vehicle's front end is even with the rear of the stall you want to park in, begin steering sharply to the right while slowly driving towards the centre of the stall. Remember, as you're turning into the stall, to check that you will not hit the vehicle on either side of the stall.

- Once your vehicle is centred in the stall, straighten your wheels and continue driving forward until you are completely in the parking stall. Although it's easy to park, backing out from this position can be hazardous. Shoulder check both your sides and rear — don't just rely on your rearview mirror. Make sure it's clear behind and on both sides before backing up. If your vision is blocked, for example, by a truck parked beside you, move back cautiously and watch for pedestrians or vehicles that you may not have seen.

Parking on a hill

The trick to parking on a hill is to turn your front wheels so that if the vehicle rolls away, it will roll into the curb and stop. If there is no curb, the vehicle should roll off the road, not into the path of other vehicles. This will prevent the vehicle from building momentum and will stop it from entering the street. The emergency brake should be applied whenever parking on a slope.



Downhill with curb

Uphill with curb

Downhill no curb

Uphill no curb

6.2 Turning

U-turns

A U-turn is when you turn your vehicle around at an intersection to travel in the opposite direction. Before making a U-turn, check that:

- there are no signs prohibiting U-turns
- you have adequate sight distance so you have time to finish the turn before encountering oncoming traffic. For example, in a 60 km/h area, you need a sight time of at least 20 seconds each way. In a 100 km/h area, you need 40 seconds sight distance clear of vehicles each way
- you have enough room to make the turn in one swing

If there is any doubt whether a U-turn can be made safely and with minimal disruption to traffic, go around the block.

The procedure for making a U-turn:

- Check that the turn is allowed and the way is clear.
- Signal the turn and approach as you would a left turn.
- Move very slowly. Turn the wheel into a full lock as soon as you can (use hand over hand).
- Once you are on full lock, slightly increase your speed.
- Throughout the turn, check to see that the way is still clear (both ways).

6.2 Turning

6. Complete the turn. Before the car is straight, start unwinding the wheel (hand over hand).
7. Straighten your front wheels.
8. Proceed as normal.

U-turns are prohibited at traffic lights unless permitted by a sign.

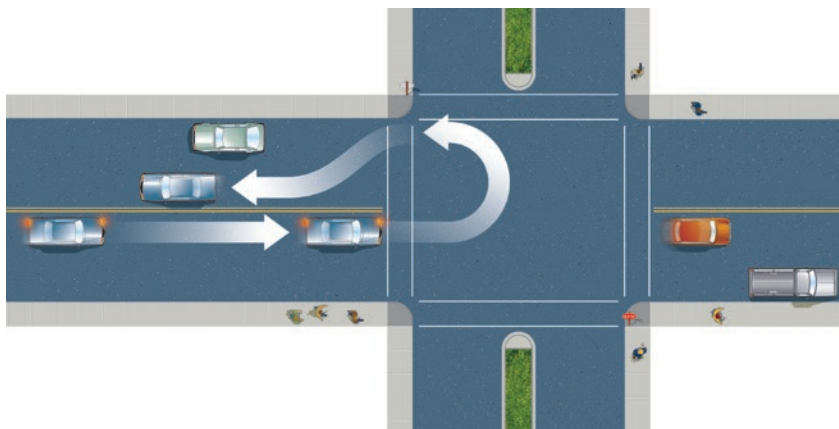

When making U-turns every effort should be made to complete the turn in the most extreme left driving lane.

Two-point turns

Before making a two-point turn, check that you have adequate sight distance so that you have time to finish the turn before any possible vehicle conflict occurs. For example, in a 60 km/h area, you need a sight time of at least 20 seconds each way. In a 100 km/h area, you need 40 seconds sight distance clear of vehicles, each way.

1. Well before the place where you wish to turn around, signal right, shoulder check, position your vehicle in the right lane and slow down.
2. Cancel the signal, proceed past the intersection, and stop your vehicle as far right as possible.

You may also move to the far right after the intersection and stop your vehicle as illustrated on the next page. Choose whichever method can be done most safely given the traffic flow.

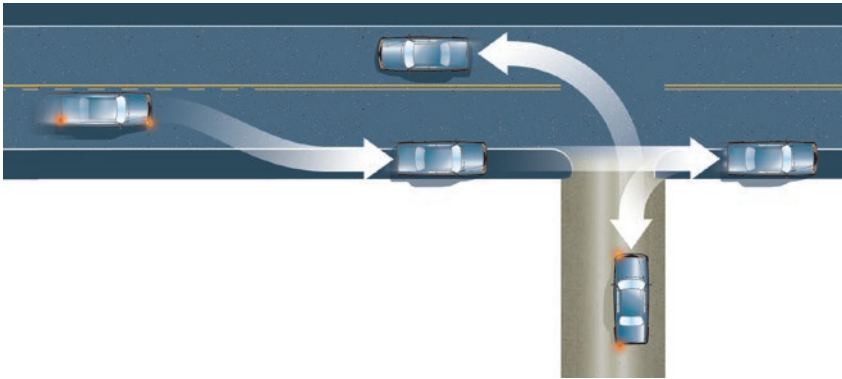

3. Signal right or turn on four-way flashers. Check for traffic.
4. Begin slowly backing up. When the rear bumper is even with the intersection, turn wheels sharply to the right. Be careful that the front of your car does not swing out into traffic. As you back into the approach, straighten the wheels and stop.
5. Signal for a left turn, check for traffic and proceed to make a left turn into the left driving lane.

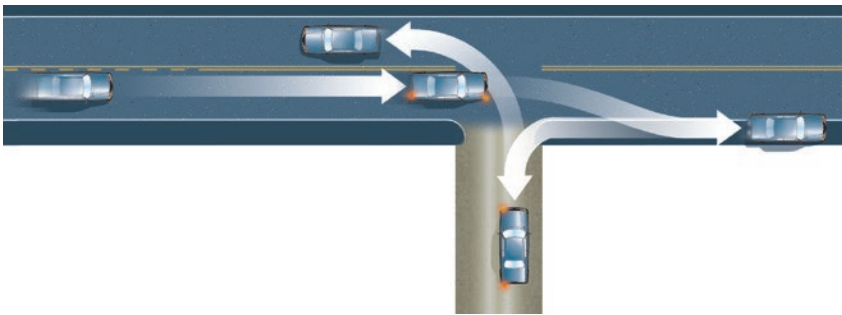

6.3 Highway driving

Highway driving requires rapid acceleration to build up speed over as short a time as possible to minimize the difference in speed with other vehicles. It's very important that you have a good judgment of the amount of time you need to safely enter the highway and that it matches the amount of time you actually have.

Some things to remember while highway driving:

- It takes a longer time to stop from higher speeds.
- Some drivers who have been driving for a number of hours can develop "highway hypnosis." They may not see your brake lights or turn signal. Be prepared to make your movements obvious and for a potential slow reaction by other drivers.

6.3 Highway driving

- The higher the speed, the less the steering wheel needs to be turned and the sooner it must be turned prior to a curve, in order to get the vehicle around the curve.
- Don't make any sudden movements of the steering wheel.
- It's safest to drive at the same speed as the other traffic, provided that the other traffic is driving at a sensible speed for the conditions and within the speed limit.

Cruise control

On a long trip you can use the cruise control, if your vehicle is so equipped, to keep your speed constant. Cruise control will save gas and make highway driving less demanding. However, there are times when you should not use cruise control, such as in urban areas, on wet or slippery roads, in traffic where the speed is highly variable or in any situation where your vision is restricted.

Restricted access freeways

A freeway is a multi-lane, divided highway, with restricted access. There should be no cyclists, pedestrians or hitchhikers. Regina's Ring Road and Saskatoon's Circle Drive are some examples of freeways.

Entering a freeway

The key to entering a freeway is to increase your speed in the acceleration lane until it matches the speed of the vehicles already on the freeway.

You also need to plan your merge:

1. While on the entrance ramp, look at the freeway traffic and determine where you want to merge.
2. Build up your speed in the acceleration lane as quickly as you can.
3. Continue to check the spot where you want to merge.
4. Signal, make your final shoulder check and accelerate into the freeway lane.
Merging at less than freeway speeds can be dangerous.

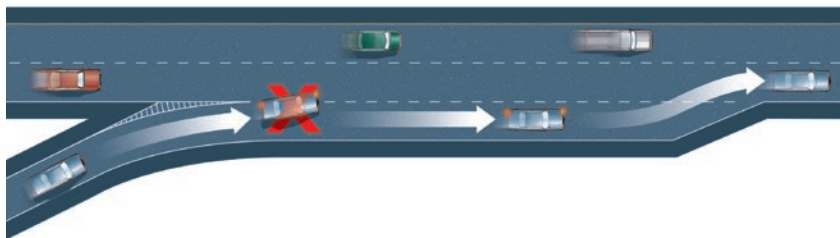

While on the freeway

Provide a safe merge for other vehicles entering the freeway from access ramps by either moving left to free the right lane or by adjusting your speed. Drive in the right lane, or perhaps the centre lane, when there are three lanes. The left lane is for passing or may be used by faster vehicles when the traffic is dense.

Keep looking up and referencing down to 12 seconds ahead so that you have advance notice of any obstacles in your path. Maintain a three-second following distance and keep at least two gates open at all times. When driving conditions are not ideal, you should decrease your speed on the freeway accordingly to maintain safe travel.

Leaving a freeway

When leaving a freeway, signal your intention and move into the deceleration lane. Slow down in the deceleration lane, not on the freeway. Some deceleration lanes are shorter than others, so watch your speed. When you exit a freeway, you are likely to under-estimate your speed when you slow down.

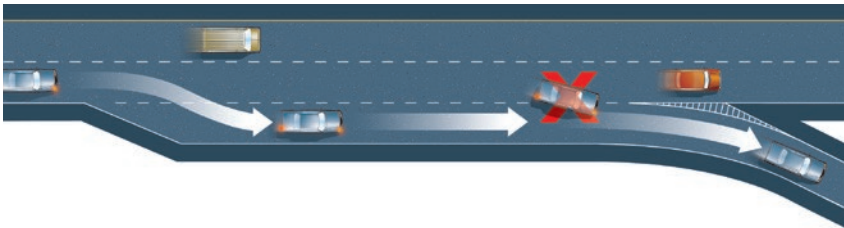

If you miss an exit

If you miss an exit, don't stop on the freeway. Don't back up on the freeway. Continue to the next interchange and return to the correct exit.

Emergencies on the freeway

If your vehicle starts to give you trouble, check your mirrors, signal, shoulder check and pull over onto the nearest shoulder as quickly and safely as possible. Slow down, turn on your hazard lights and stop on the shoulder as far right as possible.

Never stop your car on the travelled portion of the freeway. Don't wait for your car to stall on the freeway. At the first sign of trouble, pull over safely. **If possible, stay with your car. If you must cross the freeway on foot, use extreme caution.**

Turn on your four-way flashers or raise the hood to alert other motorists you need assistance. Be especially careful getting out of your car when stopped along a freeway. If necessary, exit from the door away from the traffic.

In some cities, you may encounter roadways that have some characteristics of a freeway and some characteristics of a normal street. Be alert for unexpected traffic patterns.

6.4 Passing

Estimation of safe passing time

Using time to estimate when you can pass is complicated, but it's well worth the effort required to master it. You can practise passing safely and once you can judge time well, you have a good method of judging when it's safe to pass.

You can get all the information you need to make a passing judgment from two estimates: the estimate of your safe passing time and the estimate of the closing time between you and the approaching vehicle.

The first step in developing your new technique is to find out how long it normally takes you to pass. This varies from 10 to 40 seconds depending on your vehicle, your technique and the difference in speed between you and the vehicle you are passing. To find your safe passing time, choose a divided highway or a two-way highway at a time and place when traffic is light.

First, determine your passing time as follows:

1. Follow the vehicle ahead at the same speed, but three seconds back. Note its speed.
2. Check that you can see at least 40 seconds ahead, that there are no vehicles coming the other way and that there are no intersections or solid lane markings.
3. Begin counting "Thou - sand and one, Thou - sand and two" from the point you decide to pass and begin to accelerate.
4. Signal, and at a point where you still have good vision and can smoothly change lanes around the vehicle ahead, move into the left lane.
5. Continue in the left lane until you see the vehicle you have just passed in your inside mirror. As you pull back into your original lane, signal right and continue your acceleration. **Do not decelerate** as you change lanes.
6. Continue counting until you have completed your pass. Stop your count when your left rear wheel crosses the lane line (just as you are returning to your original lane in front of the vehicle you have passed).
7. The last number you say after "Thou - sand" is your measure of passing time in seconds.

Next, build in a safety margin that you are comfortable with.

Five seconds is a minimum safety margin. For example, if your passing time is 15 seconds, add another five seconds for possible error. This will give you a cushion of five seconds if the vehicle coming towards you is approaching faster than normal or if your estimation is not accurate.

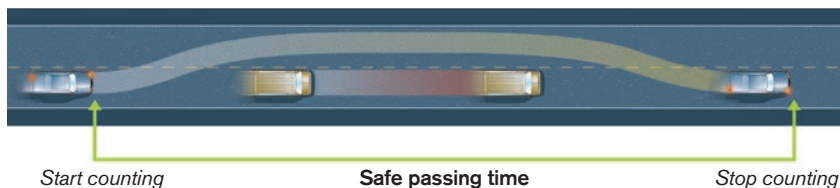

Your passing time + your safety margin = your safe passing time

Your safe passing time in this case is 20 seconds.

If you think about it, your safe passing time will also tell you the minimum sight distance needed for safe passing, even if there is nothing coming the other way.

Try this several times at highway speeds varying the difference between you and the vehicle ahead until you get a handle on what your safe passing time actually is.

Estimation of the closing time of two vehicles

This is similar to judging the time from fixed objects except now you have a vehicle coming towards you. The gap between you and the approaching vehicle will close about twice as fast as if you were approaching a fixed object.

Steps to estimate closing time:

1. Position your vehicle three seconds behind the vehicle in front.
2. Determine the point at which you could safely return to your lane if you were to pass the vehicle in front – the safe return point. For example, watch a vehicle pass and note where it pulls back into the driving lane.
3. When an approaching vehicle appears, start counting and continue counting until the vehicle reaches the safe return point ahead of you. The last number you say after “Thou - sand” is your measure of closing time.



Safe return point

Closing time

The safe/unsafe judgment

When you feel confident that you can estimate closing times reasonably well, practise judging when it is safe to pass, then check by counting time. When a vehicle is approaching, decide if it is safe to pass or not. Say “safe” or “unsafe,” then count “Thou - sand and one, Thou - sand and two” – check the actual closing time against your safe passing time to see if you were right. Keep practising until you can make the safe/unsafe judgment with 100% accuracy.

There are two advantages to practising your passing judgment in this way. First, it is completely safe because you never actually pass the vehicle. Second, your timing will be based on the actual speeds of vehicles using the highway.

Be sure to keep the type and size of vehicle you are passing in mind. For instance, when passing a motorcycle make sure you leave a greater distance between your vehicle and the motorcycle you are passing, before pulling back into the driving lane. It's easy to underestimate how much room you should allow due to the smaller size of a motorcycle.

The actual passing judgment

Now practise what you have learned. When you judge that it is safe to pass, carry out a passing manoeuvre.

Remember:

1. You have to build a minimum of a five-second safety cushion into your safe passing time. Do not give this up under any circumstance.
2. When you have enough experience with this method of estimation to be skilled and comfortable with it, extend your range. Determine the safe passing time for different situations, such as different speeds, surface conditions and longer vehicles such as tractor trailers. The passing time will vary.
3. Your safe passing time is also a measure of the shortest sight distance you need to pass, even with no oncoming traffic.
4. Your passing time will vary with the speed difference between you and the vehicle you are passing.

Being passed

When you're being passed:

1. Maintain your speed; do not speed up.
2. Slow down, move to the right of your lane and let them back into the lane.
3. If the driver passing you has misjudged, slow down and let them back into the lane.
4. When being passed by large trucks, you're likely to be pushed around by the wind. Just look where you want to go and your steering will take care of itself.

6.5 Curves and corners

The techniques for driving around curves and corners are basically the same. In a curve or corner, the vehicle will want to go straight ahead while you want to turn. If you're going too fast, or if the road is slippery, the vehicle will win and you won't get around the corner or curve. Any speed or steering adjustments required while in the curve should be very gradual to avoid losing control of your vehicle.

The most important part of driving a curve or corner is to slow down before you get to it.

To drive around a sharp curve or corner, follow this procedure:

1. **Slow down.** Take your foot off the accelerator and, if necessary, brake. It's important to **brake in a straight line**.
2. In a manual transmission vehicle, shift to a lower gear so that you have enough power to accelerate through the curve or corner.
3. Use the vision techniques on page 88.
4. Use your accelerator **gently** until you reach the mid-point of the curve, pushing down on the accelerator if you want the vehicle to go to the outside of the curve. Ease up on the accelerator if you want the vehicle to go to the inside of the curve or corner.
5. Once you reach the mid-point of the curve, unwind the steering wheel and accelerate out of the curve.

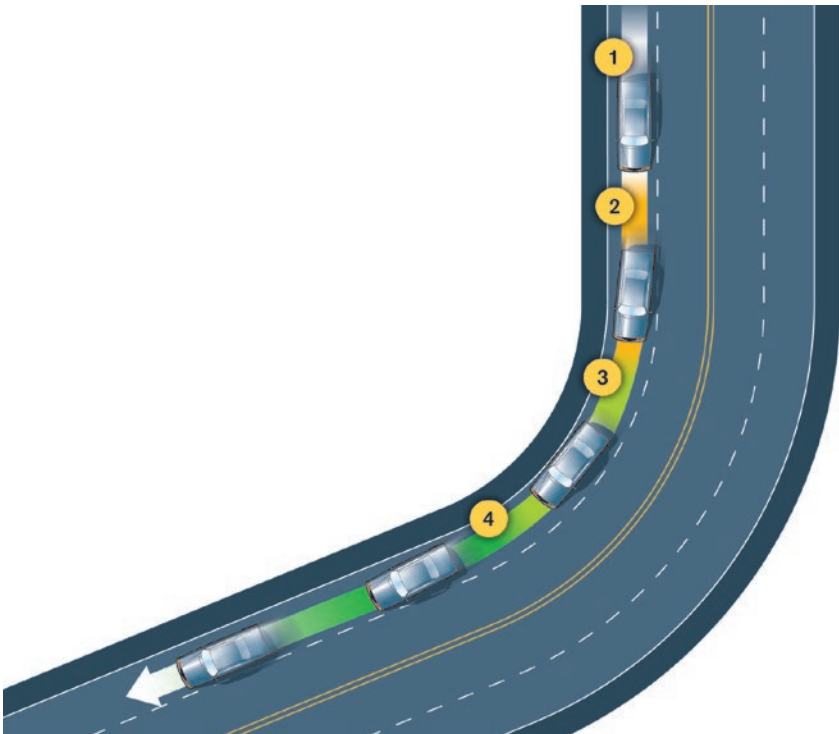

6.6 Driving in mountains

When driving in mountains, you will have shorter sight distances, so it's important that you look up, reference down and adjust your speed so that you can see at least 12 seconds ahead.

When you drive down mountains, you sometimes move faster than you wish. You'll find that shifting to a lower gear will help you to slow down. As you travel down the mountain, brake very lightly and continuously. This method of braking is least likely to overheat your brakes.

6.7 Grid, municipal and resource access roads

Saskatchewan has a large network of roads connecting its main highways.

These roads present driving challenges which differ from provincial highways. Sight distances may be shorter. There are no shoulders, curves are sharper and there are many T-intersections, which means that the road comes to an end, often with little notice.

Unlike main highways, these roads are not designed to permit you to get out of trouble if you happen to be travelling faster than the posted speed limit. The speed limits are to be taken seriously and should be regarded as **maximums** under ideal conditions. When there is no posted speed limit, the speed limit is 80 km/h under ideal conditions.

Gravel surfaces may cause problems. At times, the gravel may be deep and loose, making it difficult to steer around curves. At other times there may be so little gravel that you're actually driving in dirt, which is very slippery when wet.

When dry, gravel surfaces also create visibility problems. Every moving vehicle creates clouds of dust that make meeting and passing other vehicles very dangerous.

Railway crossings, crossroads and farm entrances are more difficult to see on these roads than when you're driving on provincial highways that provide better sight distances. You're also more likely to encounter slow-moving farm vehicles, livestock and wildlife.

Driving techniques for gravel roads

Drive at a speed suited to the conditions. This means drive slowly. When you exit from a provincial highway, slow down. Keep your eyes up. You need all the advance notice you can get.

To steer in deep gravel, grasp the wheel firmly. Expect that the vehicle will wander. You won't steer as precisely as you do on pavement, so don't fight it by turning the steering wheel too much – you could lose control.

Stay well back from dust clouds.

Always drive with your headlights on so that others can see you earlier than they otherwise might.

When meeting large trucks or farm equipment, slow down and pull as far to the right as possible. You may have to stop.

6.8 Winter driving

In Saskatchewan, it's possible that you could be operating your vehicle for at least five months of the year in winter driving conditions. It's in this period, from November to March, that most collisions occur.

Snow, ice and freezing rain reduce traction. Drifting and blowing snow, fog, whiteouts, gas exhaust clouds and frosted windows may severely limit visibility.

The main cause of collisions in winter months is failing to adjust to changing conditions.

Before heading out, be sure to check the Highway Hotline at hotline.gov.sk.ca/map for road conditions, and stay home if it says travel not recommended.



Preparing your vehicle

Winter conditions, plus the effects of extremely low temperatures, demand that a vehicle be in top condition. For this reason, a pre-winter check is a necessity, and in the end is less annoying and less costly than battery boosts, tows and being late. Give special attention to your heater and defroster.

As well as getting a tune-up and adding antifreeze to your radiator, you would be wise to have the following:

- snow tires
- block heater
- snow brush and scraper
- gas line antifreeze
- small snow shovel
- set of traction mats
- booster cables (know how to use them)

For out of town trips, add the following survival equipment:

- extra warm clothes (include footwear, mitts and hats)
- a supply of candles and matches
- tow chain or rope
- nourishing freezable food (raisins, nuts, candy)
- sleeping bags
- cellphone and charger cable

Preparing to see and to be seen

If you cannot see through your windows, you should not drive. If your lights and signals are to protect you, they must be visible. Before you drive, do the following:

- Brush the snow off your car.
- Scrape the windshield, rear and side windows.
- Clear your heater air intake (this is usually in front of the windshield).
- Clean your headlights, tail lights and signal lights.
- Be sure to clear your tissue boxes, sunglasses, papers, etc., away from defroster outlets.
- Drive with your headlights on at all times. Even on a clear day, swirling snow makes it difficult to see and to be seen.

Driving on slippery surfaces

Winter traction problems require a number of changes from summer driving techniques. The general rule for driving on slippery conditions is drive slowly.

You should not use cruise control on icy or slippery roads. This is even more important when the road may have black ice formed on it (a thin layer of transparent ice found on the road or other paved surfaces).

Traction varies tremendously with temperature changes. Icy roads will look just the same at -2 C or -22 C, but will be far more slippery at the warmer temperature. Winter driving calls for special driving skills. This means **gentle** acceleration, **gentle** braking and **small, smooth** steering movements.

Reduced traction means the grip between your tires and the slippery surface is fragile.

If you accelerate hard, you go beyond the amount of traction that is available and your wheels spin. If you brake too hard and your wheels lock, you break the traction, which means that when you turn the steering wheel, the vehicle will not turn – it will continue in the direction it was going when the wheels locked. If this occurs on ice, your stopping distance changes. In most situations, locking four wheels by pushing hard on the brakes will give you the shortest stopping distance. But on ice, especially when it's near the freezing point or if you are driving fast, you are better off to threshold-brake by pushing on the brake up to the point just before it locks. (See "Threshold braking," page 125.)

If the surface is slippery, flatten the corner or curve by positioning your vehicle in the left side of your lane prior to making your turn.

As you enter the curve, gradually steer across the lane so that as you near the mid-point of the curve the vehicle is near the right side of the lane with its wheels straight. As you exit the curve, gradually steer back across the lane towards the left side. For left curves, reverse the process. This will lessen the sideways force and reduce the chance that you will spin out. Slow entry into the curve is crucial or your vehicle may not make it around the curve.

Because there is reduced traction available for stopping and turning, reduce your speed when conditions are wet or slippery. As well, give yourself a following distance even longer than three seconds.

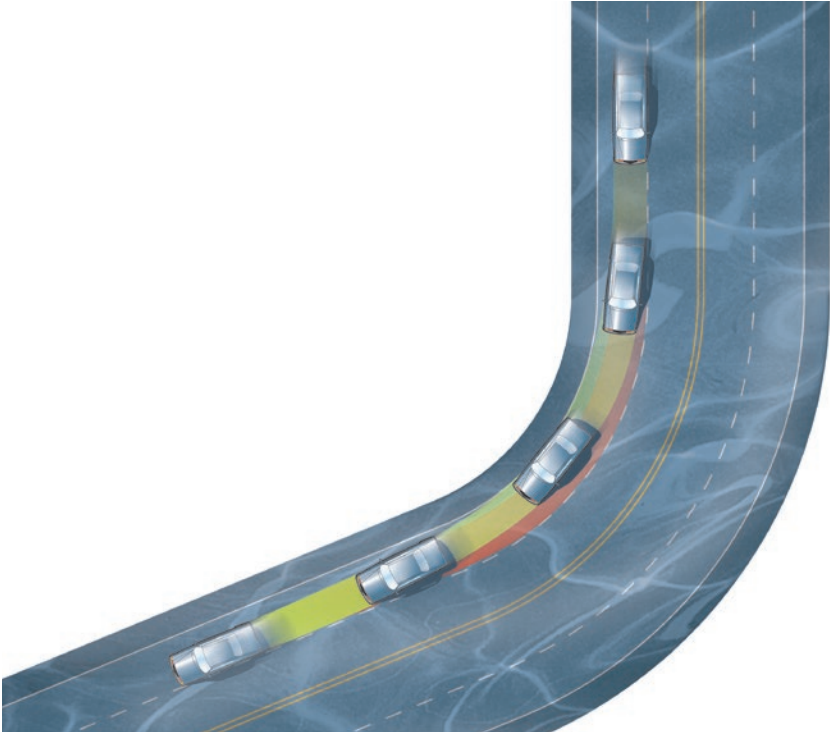

Never use cruise control when roads are wet or slippery.

How to get moving

You can usually start moving on ice or packed snow by accelerating gently. If this does not work, or if you are on a slight downgrade, try moving in second gear.

If you're stuck in deep snow, try rocking your vehicle. To do this, start forward, gently accelerate and you will move forward a little. When your wheels spin, immediately stop accelerating and hold the vehicle with the brake to stop it from rolling back. Shift to reverse, release the brake and accelerate gently. You will move back. When the wheels spin again, stop immediately. Repeat the forward-backward rocking movement, increasing the distance you move each time until you gain sufficient momentum to keep moving ahead. Be sure the wheels have stopped turning before changing gears to avoid damage to your transmission.

Search for traction. Look for sand or grit. Choose snow rather than ice. A small movement to one side will often move you from a low traction icy patch onto snow or sand. This motion can usually be completed in your lane.

How to stop on slippery surfaces

1. Shift to **neutral** (or declutch) before you brake.
2. Brake **early and gently** using the threshold technique. (See "Threshold braking," page 125.)
3. Again, search for the best traction and position your vehicle to take advantage of it.
4. Allow extra space for other drivers to stop. They may not be as skilled as you, or their traction may be worse.

Temptations to resist

1. Accelerating hard when you are passing.
2. Using cruise control on wet or slippery roads.
3. Forgetting that other drivers may not be making proper allowances for winter conditions.
4. Letting your gas tank drop below half full.

Whiteouts

Whiteouts occur when the sky, horizon and ground blend into one, making it very difficult to determine your position on the road. All shadows and distinctions disappear, so that you can barely tell where the road ends and the ditch begins.

The first snowfalls

During the first few snowfalls, drive very slowly and keep a five-second following distance. It takes time to change from your summer driving patterns. Exaggerate your gentleness on your brake and accelerator pedals and you will stay out of the line-ups at the body shop.

Survival

Lives continue to be lost in Saskatchewan winter blizzards.

Dress warmly for long trips. Do not be deceived by the false comfort of a well-heated car and wear indoor clothes on long journeys.

Before starting a long trip, listen to weather forecasts and pay attention to storm warnings. If storms develop while you're travelling, seriously consider stopping over in a town or village, rather than continuing, when there is a possibility of being stranded.

If you are stranded:

1. **Always stay with your vehicle.**
2. Keep calm.
3. Lower your downwind-side windows slightly and open the heater air vent to get fresh air into the vehicle.
4. Run the engine to get some heat, and to listen to news reports or charge your cellphone but don't run out of gas or drain your battery.
5. Keep your exhaust pipe clear of ice and snow.
6. Get into your emergency clothing before you get cold.
7. If necessary, use candles to keep warm. Be careful not to over-exert yourself by shovelling or by pushing your vehicle.

Many people die when they leave their vehicles to walk for help in a blizzard. If you stay with your vehicle, you have a better chance of surviving and are more likely to be found.

6.9 Braking

The general procedure for braking is to begin early, apply light pressure and ease up on the brake as the vehicle comes to a stop. **Always brake with your right foot.**

If you want to stop more quickly, push the brake down a little further. Remember, for normal braking you control the stop by varying the pressure. Do not push the brake down as far as it will go.

Anti-lock Braking System (ABS) – was introduced in the mid-1980s and has become standard equipment on most newer vehicles. It was designed to help drivers maintain some steering ability and avoid skidding while braking. In normal braking, ABS is not activated. During hard braking, vehicles with ABS remain stable. The brakes do not lock up, which means the driver has more steering control. How do you use ABS? Press the brake firmly and do not release until the vehicle has stopped. **Do not pump your brakes;** the ABS is doing it for you.

When the ABS is active, the brake pedal may pulsate and the car may shudder or emit clunking noises. This can startle some drivers, causing them to release the brake, but these things are normal and indicate the ABS is functioning properly.

You may think that with ABS you can stop on a dime. This instantaneous stop is not realistic. When braking on dry or wet roads your stopping distance will be about the same as with conventional brakes.

You should allow for a longer stopping distance with ABS than with conventional brakes when driving on gravel, slush and snow. This is because the rotating tire will stay on top of this low-traction road surface covering and effectively “float” on this layer.

A non-ABS-braked vehicle can lock its tires and create a snow plow effect in front of the tires that may, in some cases, help slow the vehicle. These locked tires can sometimes find more traction below this layer. It's recommended you refer to your vehicle owner's manual to become familiar with proper practices should your vehicle have electronic stability control, traction control, or other safety features.

Threshold braking

In threshold braking, you're trying to use all the braking force available without locking the wheels, i.e., you're trying for the “threshold” just before lock-up.

To accomplish this, shift to neutral (declutch) and brake until you feel one or more wheels lock, then, ease up the brake slightly until the wheels are all rolling again. Re-apply pressure until you feel one of the wheels start to lock up, ease off slightly and continue this movement, tracking the threshold until you stop. As the vehicle slows, you can brake harder before lock-up will occur.

The more slippery the surface, the less you will be able to push the brake before a wheel locks.

The skill in threshold braking comes from being able to linger just short of lock-up. To threshold brake well requires much effort and concentration. While it's usually the technique of choice, it is almost impossible to do if you panic.

Four-wheel lock braking

With this technique, you shift to neutral (declutch) and then hit the brakes very hard so that all four wheels lock at the same time. Since most cars aren't designed to do this, you need to stomp on the brake pedal and keep maximum pressure on the brake until you come to a complete stop.

Your vehicle will travel in a straight line. If all four wheels do not lock at exactly the same time, or if the surface under different tires varies, the vehicle may rotate a little before it finally stops. Even under the worst conditions (one wheel on ice, one wheel on dry pavement), the vehicle will travel in a straight line, although it may revolve around a point in the middle of the vehicle.

You need very little pressure to lock the wheels on ice. As the traction increases, you must increase the pressure to lock the wheels. On dry pavement, you really have to stomp on the brake to lock all four wheels simultaneously. You must also be seated sufficiently close to the brake pedal to get the leverage required.

The four-wheel lock will produce the shortest stopping distance on all surfaces, except glare ice. It's also an ideal technique to use if you panic because stomping on the brake is a natural reaction. Also, once you stamp on the brake, you do not have to do anything except keep pressure on the brake.

If possible, try the four-wheel lock when you are with a trained instructor. Otherwise, practise at low speeds (20 - 40 km/h) on a wet surface. If you try this procedure on dry pavement, you may damage your tires, which is acceptable if you're trying to avoid a crash, but not recommended if you are just practising.

6.10 Emergency driving

If you use the proper search patterns and see things well in advance, you should avoid most emergencies. However, as part of your IPDE method of driving, expect that other drivers may sometimes proceed when they shouldn't. This means that you will have to execute your decision in a hurry if you are to avoid a collision.

In this section, you'll deal with the techniques you need to control your vehicle during the **execution** part of an emergency situation. To become skilled in emergency techniques, you need to practise, if possible, with a trained instructor.

Where to look

The rule is simple! Look where you want to go and steer there. Don't look at the tree you want to avoid, look at the gap you want to get through.

Emergency braking techniques

Always try to brake in a straight line. Get your wheels straight and line up your vehicle so that it can go straight ahead while you're braking. Don't try to brake when your vehicle is turned – you could spin out. (See “Braking,” page 124.)

Emergency steering techniques

The difference between steering in an emergency situation and steering in a normal driving situation is the speed and amount that you need to turn the wheel.

If you do skid and need to recover, turn the wheel to correct your direction of travel. This method just takes practise. The difficult part is knowing when your wheels are straight.

At higher speeds, use the “9 and 3” steering method. (See “Hand positions,” page 101.) Twist the wheel without moving your hands on the wheel. When your hands return to “9” and “3,” you know your front wheels are straight.



Steering around an object involves three movements:

Steer

Twist the wheel in the direction you wish to go.

Counter-steer

Turn the wheel back the other way beyond the centrepoint.

Straighten out

Twist the wheel back to the point where your wheels are straight.

Timing is crucial, so it's advisable to practise this manoeuvre with an experienced instructor.

It's important, after turning around an obstacle, to get the vehicle going straight before you begin a second steering movement.

If your choice is between braking or steering, choose to steer. You can steer around an obstacle in a shorter distance than it takes to stop in front of it.

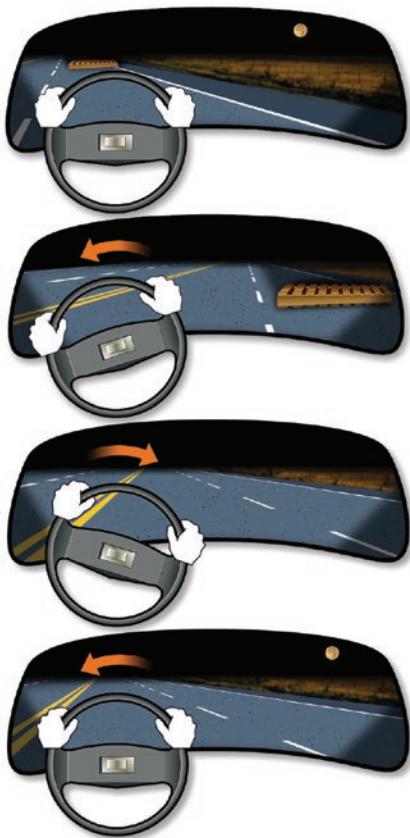

Combined braking and steering

Where you have a choice, the best method of dealing with an emergency is to combine braking and steering. Brake first, while you slow down and regain control and finish deciding where you want to go.

If you have time and you are feeling calm, threshold brake. If not, lock your four wheels. Regardless of the method of braking you use, take your foot off the brake to steer around the object. Most importantly, do one thing at a time, either brake or steer. If your wheels are locked, the car will go straight ahead regardless of how you turn the steering wheel.

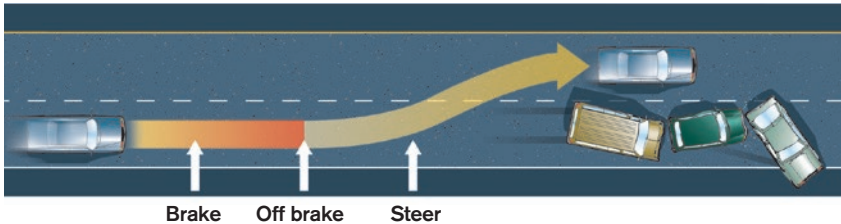

If you are driving a vehicle equipped with ABS, the best way to deal with an emergency is to brake hard and steer where you want to go.

Neutral/declutch

Providing it's recommended for your vehicle type, it's best to shift to neutral, or declutch, in all emergencies, except when you plan to use the accelerator to get out of trouble. Please refer to your vehicle owner's manual for manufacturer's recommendations in this regard.

Skidding

A skid usually occurs on a slippery surface when there is not enough traction to keep the tires rolling. You will go into a skid when it is wet or slippery if you brake or accelerate too hard or turn too sharply.

Regardless of the kind of skid, **always shift to neutral (declutch)**. Turning the wheel in the direction of the skid is correct, but complicated. A much simpler way to decide what way to steer is to look where you want to go and steer there.

Never use cruise control when roads are wet or slippery or on gravel.

Skids resulting from braking

The remedy is the same in any skid resulting from braking, regardless of how many wheels lock. Shift to neutral (declutch) and remove your foot from the brake. Look where you want to go and steer there. By shifting to neutral, you will ensure that the skid does not get worse and you will get the wheels rolling again so that you can steer.

You will probably have to correct the steering. Look where you want to go and steer there. This will usually mean steering, counter-steering and straightening out.

Skids resulting from too much acceleration

Sometimes too much acceleration or using cruise control on a slippery surface will cause the vehicle to skid. To correct this situation, shift to neutral (declutch), take your foot off the accelerator, look where you want to go and steer there. Do not touch the brake. Some corrective steering may be necessary.

Skids resulting from steering too sharply

If you turn the wheel too far to the left or right on a slippery surface, the front wheels will skid straight ahead. To correct this, you must shift to neutral (declutch) and turn the wheel back towards the centre. As the wheels move to a position where they are turned less sharply, they will begin to grip again and you will be able to steer. You actually turn the wheel in the opposite direction from which you wish to go until the wheels begin to roll. Only at this point do you look where you want to go and steer there.

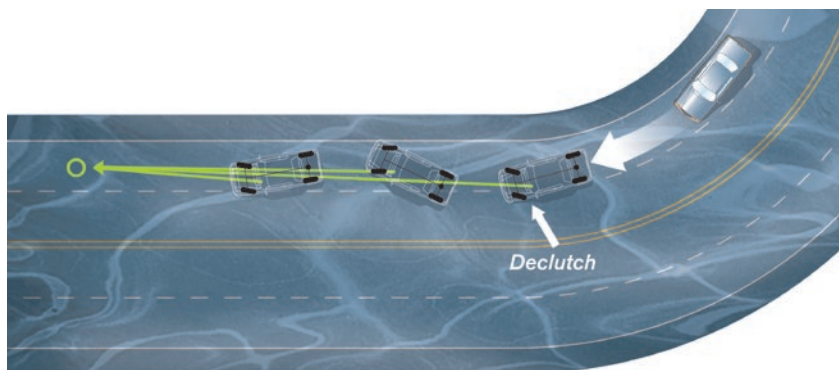

When in a skid, look where you want to go and steer there.

When skids go too far

Sometimes, when a skid has gone too far, the vehicle will start to spin. You may not be able to stop the spinning, but you do have a choice of where it spins. Shift to neutral, if you have time, and lock all four wheels. The vehicle will spin in a straight line, continuing in the direction in which it was last going. Usually, if you do this you can stay on the road.

To avoid getting into skids

To avoid getting into a skid, first adjust your speed to the conditions, then look well ahead so that you have plenty of time to react slowly and smoothly. If you must make any movements on a slippery surface, make them smoothly and gently and avoid sudden movements of the steering wheel.

Do not turn a little problem into a tragedy

Many collisions are caused by the driver's over-reaction to a possible emergency situation. If you find yourself in an emergency situation, try to remain calm and take the time to think before you act. As a skid develops, the earlier you take action, the smaller the corrective movement required and the greater are your chances of controlling it.

Drifting onto a soft shoulder

If you drift onto a soft shoulder, it's not what you do that is important, it is what you **do not do** that counts.

If your right wheels drop onto a soft shoulder, don't jerk the wheel to get back on the road in a hurry and don't brake hard.

Do not take any corrective action immediately, just steer straight along the shoulder, **gradually slowing down**. Then, when you have slowed and there are no other vehicles around, turn the wheel left and almost immediately (when you feel your front wheel come onto the road) counter-steer and straighten out.

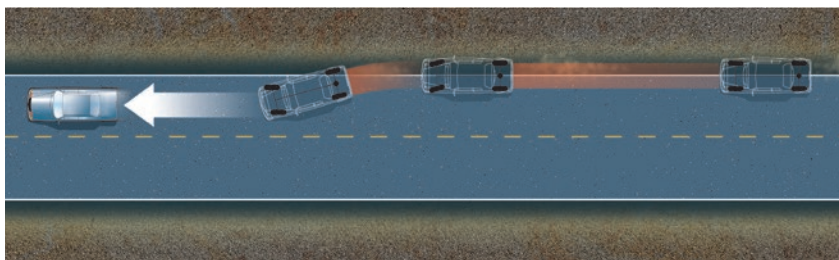

It's a simple procedure as long as you don't steer very much. You should, however, grip the wheel tightly.

If you come off in a critical location, for example, just before a bridge, then treat your return to the road like an emergency lane change and steer, counter-steer, straighten.

Ditches

With ditches, as with soft shoulders, it's what you don't do that's important.

Don't brake hard, don't turn the wheel violently and don't try to get back on the road. These actions are very likely to cause your vehicle to roll over.

The important thing is to drive down the ditch. The greater the slope of the ditch, the more you will have to steer down the ditch to keep from rolling.

To drive down the ditch, hold the wheel firmly. Look and steer gently down the slope to where you want to go. Stay off the brake. Gradually release the accelerator. If you need to steer to avoid an obstacle, do it **slowly and gradually** and, if you have a choice, choose the direction that will send you down the slope.

If you suddenly find yourself going into a ditch, do not over-react. Try to resist doing anything until you think about what you must do. You're better off to do nothing than to try the wrong thing.

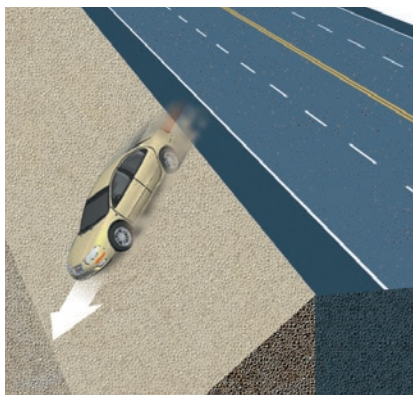
*Gentle ditch**Steep ditch*

It's perfectly all right to drive in a ditch to avoid a rollover, provided you don't hit an approach road or something hard. The main cause of rollovers is attempting to return to the road too early. You may have to be towed out, but that is a small price to pay compared to rolling the car.

Blow-outs

With a front or rear tire blow-out, do not over-react. Look where you want to go and steer there, holding the steering wheel firmly. Gradually ease off the accelerator and gently brake. Once you have slowed down, steer the vehicle off to the side of the road.

Blow-outs can cause tremendous steering and wheel vibration. Do not be alarmed.

Remember, gentle braking will improve stability and reduce steering and wheel vibration.

Rear wheel blow-outs can cause the back of the car to fishtail. Do not over-correct your steering. Just brake gently and steer where you want to go. Remember to shift to neutral (declutch).

Brake failure

Vehicles are manufactured with a two-circuit hydraulic brake system, and total brake failure is very rare. If one half of the system fails, the brake warning light will usually come on when you apply the brakes and you'll have to push much harder to slow or stop the vehicle. Even if the brake pedal goes right to the floor, do not give up. It'll still have stopping power.

You can help slow the vehicle by using the parking brake. Try to avoid having the rear wheels lock as this will cause the vehicle to spin around. By adjusting the parking brake release, you will make it easier to vary the pressure and avoid locking.

Don't pump your brakes. It's the wrong thing to do with a modern brake system. If the vehicle pulls to one side, grasp the wheel firmly, counter-steer and shift to a lower gear. After the car has stopped, do not drive any further. Call for help.

Power steering or power brake failure

Most vehicles have some form of power assistance for braking and steering to reduce the force necessary to operate the controls.

If the engine stalls, you'll lose your power assistance and will have to apply a great deal more force to the brake or steering wheel to maintain control. Try shifting to neutral and re-starting the engine, then return the shift lever to drive.

Accelerator sticking

If your accelerator sticks, don't panic. Shift to neutral (or declutch), slow down, pull over and stop. Then, turn the key off and try unsticking the pedal with your feet.

Headlight failure

If your headlights suddenly go out, immediately slow down to keep your original course, pull over and stop. Check the headlight switch and the dimmer switch. If these don't work, put on the parking lights or hazard lights.

Animals on the road

Peak times

Wild animals are unpredictable but there are times when the risk of a collision is particularly high. Be alert during the months of May and June when animals are drawn to ditches for road salt and to escape biting insects. Animals are also especially active in the late fall and early winter during mating season and migration. The peak times for collisions are dawn and dusk.

Watch your speed

Yellow wildlife warning signs indicate areas of high risk. No matter the season or time of day, it's important to watch for signs of wildlife and reduce your speed accordingly. Slowing down reduces the distance required to stop and decreases the force of impact in the event of a collision.



Be alert

It's important to constantly scan the road from shoulder to shoulder. Being alert is still your best defence to prevent a collision. When you see an animal at the side of the road, slow down and pass by slowly. For night driving, look for the glowing eyes of animals and use your high beams whenever possible.

When encountering an animal, try to do the following:

- Remain calm if an animal appears on the road in front of you. If you have time to stop, do so at a safe distance and stay alert. When one animal crosses the road, others often follow. You can also sound your horn to scare wildlife away from the road.
- If an animal appears suddenly and surprises you, remember to brake firmly and stay in control of your vehicle. Avoid swerving because you may turn into oncoming traffic or roll into the ditch.
- If the animals are being herded or if you approach horseback riders you should slow down and wait for the herder or rider to move the animals across the road or to one side and indicate that it's safe to proceed. Do not use your horn as it may panic or scatter the animals.

When a collision is unavoidable

Sometimes collisions with wildlife are unavoidable even if you take every precaution and remain alert at the wheel. In these circumstances, try to remain calm.

- Aim your vehicle at the spot where the animal came from, not where it's going.
- Try for a glancing blow rather than a head-on encounter and let up on your brake just before you collide. This causes the front of your vehicle to rise slightly and reduces the chances of the animal going through your windshield.
- Hitting an animal can be a traumatic experience. If possible, move to the shoulder and turn on your hazard lights. Take a moment to regain your composure and then assess the damage to your vehicle.
- Don't approach the animal, especially if it appears to be wounded. Injured animals can be dangerous.
- Call the police or your local RCMP detachment if there are human injuries or significant damage to your vehicle. If the damage is less severe, you may continue driving and follow regular SGI claims reporting procedures.
- Call the Conservation Officer Service if there is a dead or injured animal to report.

6.11 Understanding collisions

When you know your front steps are icy, you take special care when going down them. By being aware of and understanding some basic traffic collision statistics, you'll know to take special care to avoid high-risk situations.

Two-thirds of the time, the causes of collisions are related to driver condition or improper action.

Some of the most common contributing factors to collisions are:

- driver inattention
- failing to yield the right of way
- driving too fast for road conditions
- driving under the influence of alcohol or drugs
- disregarding a traffic control device
- driver inexperience or confusion
- following too closely
- backing unsafely
- changing lanes or passing improperly

Other information you should know about collisions:

- Most traffic collisions occur during peak traffic times such as late afternoon and early evening.
- November and December usually have the highest total number of collisions.
- August and October are when the most severe collisions and the most traffic deaths occur.
- Alcohol is a factor in about 4% of all traffic collisions and in about 40% of all fatal collisions.
- Approximately 90% of all collisions in rural Saskatchewan are single-vehicle collisions.
- Wearing a seatbelt can decrease your chances of being killed or seriously injured in a collision by as much as 50%.

6.12 What to do if you're in a collision

The first few minutes after a crash can be critical if the consequences are to be minimized. If you haven't been seriously injured during the collision, the following steps should be followed as quickly and calmly as possible.

Protect the scene

If any gasoline has spilled, make sure the ignitions of any damaged vehicles are turned off and any cigars or cigarettes are extinguished.

Warn approaching traffic by setting up flares (well away from the crash scene) or delegating two people to signal at each end of the collision scene. Turn on the hazard lights of all undamaged vehicles at the scene. This is particularly critical during darkness or at times of reduced visibility when the risk of subsequent collisions is very high.

Check all injuries

Make an initial survey of damage, checking for hidden victims. Call 9-1-1 and administer first aid to the injured in order of priority. Injured persons should be moved only if they are in danger of drowning, suffocating, burning or being electrocuted.

If you have not had formal training in first aid, follow these tips:

- If the person is unconscious, be sure their air passages are clear. False teeth, chewing gum, vomit or mucus can block air passages.
- If the person is not breathing and you're familiar with mouth-to-mouth or artificial respiration, begin the procedure immediately.
- Stop bleeding by applying direct pressure over the wound. A clean piece of tissue or handkerchief may be used. If there is a depressed skull fracture, pressure should not be applied.
- If a person is pinned in a car, do not attempt to move them, but be sure the head and spine are firmly supported.
- Reassure the injured individual and stay with them until an ambulance or other vehicle is available to take them to the hospital.
- Give all information on the first aid that you have applied to the ambulance attendant and the police.

Contact the police

All crashes involving injury or death, hit and run, an impaired driver, an out-of-province vehicle or where a vehicle must be towed from the scene must be immediately reported to police.

Be prepared to give an accurate description of the crash location, the number of injured persons, the severity of the injuries and any other support services that may be required, such as ambulance, firefighting, rescuing or towing. Stay on the phone long enough to make certain that all the information has been recorded.

Check for witnesses

Record the names of any witnesses to assist the police with their investigation. Keep a copy of the names for your insurance company or lawyer in case any legal action follows.

Take photographs

Take photographs of the collision scene, vehicles involved in the crash and road conditions.

When to provide a report to police

If asked, you're required to provide a statement to police if you were a driver, passenger or witness.

If you're involved in a collision in which there are no injuries or deaths, that does not involve a hit and run or an impaired driver, that does not involve an out-of-province vehicle and where all vehicles can be driven from the scene of the collision, you must provide the vehicle owner with your name, address, driver's licence number and any relevant insurance information.

Dangerous goods

If a vehicle involved in the collision is a truck displaying a dangerous goods placard, you must take extra care in case the vehicle is discharging a dangerous substance.

Power lines

If your vehicle comes in contact with a power line, stay in your vehicle and call SaskPower at 306-310-2220. If it's an emergency, call 9-1-1 and stay in your vehicle until help arrives.

If your vehicle is on fire and you must exit the vehicle:

1. Make sure there are no wires in your way.
2. Stand in the doorway of the vehicle with feet together and cross your arms over your chest.
3. Jump as far away from the vehicle as possible and land with both feet together.
4. Do not touch the vehicle.
5. Keep arms crossed, feet together, and hop at least 10 metres to safety.

If you see a collision involving a power pole, fallen line or transformer:

1. Park at least 10 metres away and assess the situation before getting out of your vehicle.
2. Don't touch the other vehicle(s), power pole, fallen line or transformer because they may be energized.
3. Call 9-1-1 and provide a detailed description of the scene and the electrical hazard.
4. Keep yourself and others at least 10 metres away and wait for emergency personnel to arrive.

Visit saskpower.com for more information on vehicle collisions and electrical safety.

Exchange information with other drivers

As a driver in Saskatchewan, you're required to provide your name, address, driver's licence number and vehicle licence plate number to any other persons involved in a collision, regardless of the severity. You should also record the licence plate number of all vehicles involved in the collision. If a non-Saskatchewan vehicle is involved, or if you are involved in a collision outside Saskatchewan, you're also required to provide information on the company that insures your vehicle.

Don't admit fault or any other liability before discussing the details of the collision with your insurance adjuster.

Don't offer to pay for any repairs or accept payment for repairs unless you're prepared to handle the matter without the help of your insurance company.

Report to SGI

To report your claim:

- Visit www.sgi.sk.ca and use the SGI Auto eClaim registration service.
- Call the claims centre closest to your home (see the SGI information pages in the front of your SaskTel phone book).
- Call 1-844-TLK-2SGI (1-844-855-2744).

When you report a claim, you'll need to have your vehicle appraised and the damage assessed. You can set up an appointment at an SGI claims centre or your adjuster may tell you that you can take your vehicle to an SGI-accredited repair firm to complete the assessment. To help you avoid delays, please don't visit a claims centre for an appraisal without first calling the claims centre closest to your home or using eClaim.

If your vehicle is not driveable, call the claims centre closest to your home to make arrangements with an adjuster. Your vehicle will be towed to a location where the damage can be appraised.

To speed up the process when you report your claim, have the following information on hand: your driver's licence, the vehicle registration and, if you have one, your auto extension policy number.

Collisions involving injury, death, hit and run, an impaired driver, vehicles that have to be towed from the scene or an out-of-province vehicle must also be reported to the police.

An appraiser will assess the damage to your vehicle and the cost of repairs. Once the appraisal is done, you will receive a printout outlining the cost of repairs if your vehicle is repairable.

Once your adjuster has confirmed your coverage, you may have the vehicle repaired at the auto body shop of your choice. SGI doesn't direct customers to any particular repair facility.



If your vehicle cannot be repaired, your adjuster will advise you of the process for "total loss" vehicles.

If you're injured in a crash, you should immediately contact an injury claims centre or rural branch office nearest you.

For further information on the auto claim process please refer to the *You and Your Auto Claim* brochure available at all SGI claims centres and motor licence issuers.

After hours

You may report a claim by telephone after regular office hours:

Monday to Friday – 5 to 8 p.m.
Saturday – 8 a.m. to 8 p.m.
1-800-647-6448

Out-of-province crashes

If the crash occurs outside of Saskatchewan, call, fax or write:

SGI Out-of-Province Claims Dept.
440 Fleet St., Regina, SK S4N 7N7
Telephone 1-800-647-6448
Monday to Friday – 5 to 8 p.m.
Saturday – 8 a.m. to 8 p.m.

Your file will be assigned to a team of adjusters to help you with your claim. In the case of a loss outside Saskatchewan, SGI may also provide you with the name of an independent adjusting firm in your area to assist you with your claim.

6.13 Impairing factors (other than drugs and alcohol)

Fatigue

It's not wise to drive when you're tired or sleepy, particularly if you are driving along a straight road where the chances of falling asleep are high.

An early warning sign of fatigue is noticing you're not looking as far ahead as you should, or not moving your eyes in the proper search pattern. Rather, you tend to stare straight ahead.

What can you do about it?

- Recognize and **admit** that you're becoming tired. Some highways have rumble strips along the shoulder line and, in a few places, on the centre lines to alert drivers when they drift out of their lane.
- **Stop** and rest.
- Change drivers when you **start** to feel tired.

If you can't stay awake, **then for your safety and the safety of others, get off the road!**

Personal stress and illness

By now, it should be clear to you that driving places heavy demands on your ability to think clearly. Emotional and physical stress – worry, grief, anger, joy, a toothache, a headache – anything that is really bothering you, will distract you from the thinking part of your driving. If you know you're under stress, either emotional or physical, **do not drive**. Arrange to be driven by someone else who is not involved in the emotional situation and who is physically well.



Aggressive driving

Slow moving traffic, a motorist who doesn't signal, a seemingly endless stream of pedestrians – they can all frustrate the average driver. Aggressive driving, more commonly known as road rage, occurs when a motorist becomes angry, hostile or furious behind the wheel. And it's not only yelling obscenities or running other drivers off the road that are signs of road rage. The slightest variation in driving behaviour, no matter how minimal, is still considered road rage.

To ensure a safe trip, it's recommended that drivers:

- don't take traffic problems personally
- avoid eye contact with an aggressive driver
- don't make obscene gestures
- don't tailgate
- use your horn sparingly
- don't block the passing lane
- don't block the right turn lane

If you notice someone on the road who is driving aggressively, the best thing you can do to ensure your safety is to pull over and let that person pass by you.

Fog, dust, heavy rain and poor visibility

These factors may impair your vision:

- Make sure that your headlights and tail lights are on and clean so that other people can see you.
- Adjust your speed to the number of seconds you can see ahead. If you can't see 12 seconds ahead, slow down until you can.
- In fog, blowing snow or heavy rain you will see better if you drive with your lights on low beam.
- The smear that windshield wipers sometimes create may be removed by using a good windshield wiper fluid or a sprinkle of ordinary detergent.
- If you have already slowed down and still cannot see 12 seconds ahead, find a safe place as soon as you can and get off the road.



Be aware that during the first 10 minutes of a rain storm, the roads are the most slippery. The solution to driving in heavy rain is to slow down, making only small and gentle movements with your brake, accelerator and steering wheel.

Cellphones

Many collisions are the result of driver distraction. Many people talk or text on a cellphone while driving, which can have dangerous consequences. As a result, there is legislation that prohibits the use of a cellphone without a hands-free headset while driving.

The following are key tips to remember when using a cellphone in your vehicle to ensure a safe ride:

- put your cellphone in a place where it won't tempt you, such as the back seat, or switch it off or to airplane mode while you drive
- always use a hands-free unit (experienced drivers only, see page 23)
- become familiar with your phone and its features – before you try to use the hands-free unit while driving
- don't dial while driving – instead, pull off the road
- be a good Samaritan by reporting emergencies and road hazards
- never take notes or look up phone numbers while driving
- avoid stressful or emotional conversations while on the road; you can always pull over or end the conversation
- do not use a cellphone when refueling your vehicle
- most importantly, whenever possible, pull over to a safe spot on the roadside to use the phone

See **Distracted driving** page 23.

Cigarette smoke

Open the windows while smoking. Vehicles with children in them are non-smoking areas; it's illegal to smoke while children are in the vehicle.

Cigarette smoke will gradually cause a film on the inside of your windshield and windows. If people who smoke use your vehicle, clean the inside of your windows with window cleaner as soon as you notice the start of a build up.



7. Drinking, drugs and driving

7.1 Alcohol

Facts about drinking and driving in Saskatchewan*:

- A drinking driver is involved in four out of every 10 fatal collisions.
- There is a drinking driver in approximately 7% of all collisions where someone is injured.
- Of the average 39 people killed, 26 were drivers, seven were passengers, and eight were pedestrians.
- Of the average 39 people killed, 21 were killed on provincial highways, eight on rural roads, four on urban streets, and six on First Nations roads.
- Those aged 25-34 are involved in the most alcohol-related collisions.
- Alcohol, although legal, is an addictive drug that depresses the central nervous system (brain) and may change your mood and behavior.

* Based on 2015 to 2019 five-year average.

The impairing effects of alcohol on the brain

Alcohol affects everyone differently. Blood alcohol content (BAC) may be affected by age, gender, physical condition, and amount of food consumed, medication and other factors. Also, different mixed drinks contain different amounts of alcohol, so it's important to know how much alcohol has been consumed, not just how many drinks the person has had.

Sequence of effects on the body

Alcohol is absorbed into the blood stream very quickly. As blood alcohol levels start to rise, the brain becomes increasingly sedated or drugged.

1. Judgment

The first part of the body affected by alcohol is the brain, particularly the part of the brain that allows you to think clearly and make good decisions. Its sedative effect impairs judgment in a way that is usually not noticed by the drinker. The part of the brain that controls social inhibitions is also affected, causing people to say and do things they normally would not. These effects start with one drink.

2. Muscle control

The second part of the body affected by alcohol is muscle control. Due to the small muscles in the eye being very susceptible to the effects of alcohol, vision can be significantly affected, even at low alcohol levels.

Many people wrongly assess their ability to drive after drinking by observing physical dexterity (staggering, etc.). This is incorrect as the greatest percentage of alcohol-related collisions result from faulty thinking during the identification, prediction and decision parts of the driving task and not as a result of poor execution (steering, braking, etc.).

The brain functions that are first affected by alcohol consumption are not only important to our ability to drive safely, but are the same ones required to make rational decisions about not driving after drinking. For this reason, you must make the decision to separate your drinking and driving and make the necessary alternate transportation plans before you have that first drink!

It doesn't make sense to drive after drinking. For more information on the effects of alcohol and drugs, contact your nearest Alcohol and Drug Services office.

How alcohol affects you

BAC	Typical Effects	Predictable Effects on Driving
.02%	<ul style="list-style-type: none"> Some loss of judgment Relaxation Slight body warmth Altered mood 	<ul style="list-style-type: none"> Decline in visual functions (rapid tracking of a moving target) Decline in ability to perform two tasks at the same time (divided attention)
.05%	<ul style="list-style-type: none"> Exaggerated behavior May have loss of small muscle control (e.g., focusing your eyes) Impaired judgment Usually good feeling Lowered alertness Release of inhibition 	<ul style="list-style-type: none"> Reduced coordination Reduced ability to track moving objects Difficulty steering Reduced response to emergency driving situations
.08%	<ul style="list-style-type: none"> Muscle coordination becomes poor (e.g., balance, speech, vision, reaction time, and hearing) Harder to detect danger Judgment, self control, reasoning and memory are impaired 	<ul style="list-style-type: none"> Concentration Short-term memory loss Speed control Reduced information processing capability (e.g., signal detection, visual search) Impaired perception
.10%	<ul style="list-style-type: none"> Clear deterioration of reaction time and control Slurred speech, poor coordination, and slowed thinking 	<ul style="list-style-type: none"> Reduced ability to maintain lane position and brake appropriately
.15%	<ul style="list-style-type: none"> Far less muscle control than normal Vomiting may occur (unless this level is reached slowly or a person has developed a tolerance for alcohol) Major loss of balance 	<ul style="list-style-type: none"> Substantial impairment in vehicle control, attention to driving task, and in necessary visual and auditory information processing
.16% and greater	Extreme crash risk!	

(Guide based on averages – not for legal use)

Information borrowed from Centre for Disease Control and Prevention

Likelihood of a crash

As the concentration of alcohol in the bloodstream increases, the body loses more and more of the functions required to drive safely. The increased likelihood of a crash begins long before drivers feel drunk or severely impaired.

It's important to understand BAC and its impact on driving at various levels. Driving impaired, even at low levels, is a real gamble.

The only truly safe BAC is 0%.

	.05-.09% BAC	.10-.14% BAC	.15+% BAC
Increased likelihood of a crash	11x	48x	380x

BAC and time

Only time can eliminate alcohol from the body. You cannot successfully sleep off a night of heavy drinking in a few hours. If you go to bed intoxicated with a BAC of .25% and alcohol leaves the system at a rate of approximately .015% per hour, this might be a picture of what happens:

Time	Activity	Sample BAC
Midnight	goes to bed	.25
1 a.m.	sleeps*	.235
2 a.m.	sleeps*	.22
3 a.m.	sleeps*	.205
4 a.m.	sleeps*	.19
5 a.m.	sleeps*	.175
6 a.m.	sleeps*	.16
7 a.m.	gets up for work	.145
8 a.m.	feels dry mouth	.13
9 a.m.	at work	.115
10 a.m.	still legally intoxicated	.1
11 a.m.	spills coffee	.085
Noon	still feels tired	.07
1 p.m.	mind feels foggy	.055
2 p.m.	feeling irritable	.04
3 p.m.	starting to feel better	.025
4 p.m.	head clearing	.01
5 p.m.	goes home	.00

* Very restless sleep with a lot of tossing and turning.

Note: The above situation is only an example. Alcohol effects each person differently.

7.2 Drugs

Facts about drugs and driving in Saskatchewan*:

- Over 60 collisions involving a drug-impaired driver resulted in more than 35 injuries and three deaths.
- Drug-impaired drivers do not react or make decisions as quickly as a sober driver. Their attention, judgment, motor skills, balance, and co-ordination are all impacted.
- The combination of alcohol and drugs creates a synergistic effect and significantly increases impairment levels.

* Based on 2015 to 2019 five-year average.

Prescription, over-the-counter, and recreational drugs

Many drugs affect your brain functioning and some directly affect your driving.

Cannabis

Some people think that cannabis is a safer substitute to drinking, but it can cause concentration to wander, which can affect reaction times. It can also cause paranoia, drowsiness, distorted perception and a sense of disorientation – all of which could cause you to lose control at the wheel.



Cannabis is the most commonly traced drug in drivers. Even though the effects fade after a matter of hours, it can be detected in the blood for up to four weeks. In theory, this can compromise the driver if they tested positive, even if their driving wasn't adversely affected at the time.

Some experts claim that smoking a cannabis joint has roughly a similar level of impairment on driving ability as drinking four pints of beer. Also, reports show that in the majority of fatal collisions where cannabis has been detected in a driver's body, alcohol has also been detected. Alcohol alone or in combination with cannabis increases impairment, collision rate and collision responsibility (the same can be applied to other drugs too).

Depressant drugs

Like alcohol, other depressant drugs include sedatives or tranquillizers (used to treat anxiety, depression and sleeping disorders, e.g., valium), antihistamines (often used in flu, allergy and hay fever remedies) and painkillers. These drugs slow down your brain and body; they blunt alertness and reduce motor coordination. This affects a person's ability to drive safely in a way similar to alcohol. Any drug that causes drowsiness can also affect a person's ability to drive safely.



People who drive after using any type of depressant can't react as quickly when they need to. Their vision is affected, and may be blurred or doubled. Depth perception is altered, making it hard to tell whether other vehicles, pedestrians or objects are close or far away. Their driving is more likely to be careless or reckless – weaving, speeding, driving off the road, and (too often) crashing.

If the label advises against operating heavy machinery, consider it a warning not to get behind the wheel of a vehicle.

Stimulants

Stimulant drugs, such as caffeine and amphetamines, may increase alertness, but this does not mean they improve driving skills. The tired driver who drinks coffee to stay awake on the road should be aware that the stimulant effect can wear off suddenly, and that the only remedy for fatigue is to pull off the road and sleep. Amphetamines do not seem to affect driving skills when taken at medical doses, but they do make some people over-confident, which can lead to risky driving. Higher doses of amphetamines often make people hostile and aggressive.

If you think drug taking has little, or even a positive impact on your driving, you could be tragically mistaken. It's important to bear in mind that it can be hard to determine exactly how a drug will affect your driving ability – impairment caused by drugs can vary according to the individual, drug type, dosage, the length of time the drug stays in your body, or if the drug has been taken with other drugs or alcohol.

When taking prescription or over-the-counter medications, it's wise to consult with your doctor or pharmacist before driving.

Illegal drugs

Illegal drugs impair your driving. They can alter your perception of time and what you see. They can make you hallucinate or miss things you should see. They can put you to sleep.

Cocaine

This is a psycho-stimulant that can lead to misjudging driving speed and stopping distances. It can also cause a distorted sense of light and sound and a feeling of overconfidence, which can lead to aggressive and erratic driving. While it can make you feel alert at first, the effects wear off quickly, leading to an increased danger of falling asleep at the wheel.

Ecstasy

A stimulant drug with hallucinogenic properties, ecstasy can distort your sense of vision and heighten your sense of sound. Your concentration can be affected, while you may become over-confident and more likely to take dangerous risks.

Ketamine, LSD and magic mushrooms

Drugs such as these with hallucinogenic properties can strongly influence the senses, so drivers may react to objects or sounds that aren't there and place themselves and other road users in danger. Coordination skills are likely to be greatly affected, and you may experience anxiety, blurred vision and a sense of detachment from reality – all of which could be deadly on the road.

Speed (amphetamine)

While amphetamines might give you a sense of heightened alertness and confidence, they can be highly dangerous for drivers as they distort your perceptions and can make you feel anxious, prone to panic attacks and lose coordination.

Drug-impaired driving is considered as serious an offence as alcohol-impaired driving, and carries the same penalties.

There are no illegal drugs that improve your driving. They all make it worse. Don't drive after using any drugs.

7.3 Drinking and drugs combined

Many people think that driver impairment is caused exclusively by ingestion of alcohol. The truth is that the alcohol in one's body will determine their blood alcohol level. However, if that person already has another drug in their system, the impairing effect on the functioning of the central nervous system (brain) is far greater than the impairing effect of the alcohol and the impairing effect of the other drugs combined; it's not a simple adding together of impairment, but rather a multiplier effect!

This is the synergistic effect! What it means is that the whole is greater than the sum of its parts, or $1 + 1 =$ more than two. When combining drugs and alcohol it causes a multiplying effect. This has an unpredictable effect on driving and can be deadly.

Perhaps a few real life examples would be helpful to understand this synergistic effect. Assume that a drink is:

- 1 bottle of regular alcohol content beer; or
- 5 ounces table wine; or
- 3 ounces fortified wine (port or sherry); or
- 1-1/2 ounce hard liquor (rye, rum, vodka etc.).

Combined with:

- anti-depressants
- gravol
- antihistamines
- valium

We find that there is a predictable synergistic effect related to the level of impairment caused by a certain number of drinks when combined in this manner.

Number of Drinks	Combined With	Equivalent to Number of Drinks
2	Antihistamine (Cold Remedy)	= 4 to 5
2	Marijuana (1 joint)	= 5 to 6
2	Tranquilizer (Valium – normal dose)	= Approximately 6
2	Gravol	= Approximately 6

It must be noted that the dosage of the drug will have a serious effect on the “equivalence to number of drinks” estimates. Hydroponically grown marijuana, for example, is much stronger than the light dosage drug used in compiling the figures for this chart.

In all cases, the Intoxilyzer reading would indicate just the blood alcohol level caused by two drinks, but the actual impairment of central nervous system function would be equivalent to a much higher blood alcohol level.

Understanding the synergistic effect of alcohol combined with other drugs could be a lifesaver.

Students Against Drinking and Driving (SADD)

SADD is a positive lifestyle promotional program that attempts to make drinking and driving socially unacceptable among young people and encourages them to help each other change their attitudes about drinking and driving. With the help of an adult leader, students develop and promote the program themselves using assemblies, rallies, classroom sessions and social activities. Parents are encouraged to support the program by attending SADD functions and entering into a contract with their teenager whereby each agrees to always seek safe, sober transportation home.

For more information, contact SADD at 306-757-5562.

8. Complying with the law when driving

8.1 *The Traffic Safety Act*

Cities, towns and some villages have their own set of 'rules of the road,' known as bylaws. These rules are necessary as each urban centre has special driving situations. However, bylaws must complement *The Traffic Safety Act*, Saskatchewan's traffic laws.

Enforcement

To permit the police to function effectively, they've been given certain powers. You're required to comply with the requests or demands of the police when they are carrying out their duties.

Stopping when signalled by police

Police can signal you to stop using their red/blue lights, a special stop light, voice commands or hand signals. You must pull over as close to the right-hand edge of the road as possible and stop before entering the next intersection.

Producing driver's licence and registration

If requested, you must show the police your driver's licence and vehicle registration. If you don't have them with you, the police may allow you up to 48 hours to produce them.

Unsafe vehicles

The police may require you to submit your vehicle for a safety inspection. If they find that your vehicle is unsafe, they can order you to take it off the road and to not drive it until it has been repaired.

Vehicle impoundments

If a vehicle is being operated in violation of traffic laws, or presents a hazard by being parked within the traveled portion of a roadway, it may be impounded by police under the SGI Vehicle Impoundment Program.

Impoundments are based on the actions of the driver. Any vehicle can be impounded, including passenger vehicles, trucks and commercial vehicles.

There are three types of impoundments:

1. **Impaired driving impoundments** - Includes both drug and alcohol impairment.
2. **Unauthorized driver impoundments** - Includes driving while suspended or without a valid driver's licence. The vehicle will be impounded for 30 days, if it's the driver's second occurrence in a two-year period the impound length is 60 days.
3. **Rules of the road impoundments** - Vehicles will be seized when drivers commit certain high-risk offences. These offences contribute to unsafe roads and impact the severity of collisions. Anyone stopped by law enforcement who is being charged with an offence, meeting the criteria outlined in the chart on page 151 will have the vehicle they are driving impounded for the following impoundment terms.

Impoundment Reason	On Each Offence	2nd and Subsequent Offence (within a 12-month period)
Driving as a learner while unaccompanied	n/a	3 days
Driving an unregistered vehicle	n/a	7 days
Stunting	n/a	3 days
Exceed speed limit by at least double the speed	n/a	7 days
Exceed speed limit by more than 50 km/h	7 days	n/a
Contest of speed or race with other vehicles	30 days	n/a
Driving without due care or reasonable consideration	n/a	7 days
Using, holding, viewing or manipulating electronic equipment while driving		
Fail to stop for a peace officer	7 days	n/a
Certain prescribed Criminal Code offences	30 days	n/a

The vehicle will be impounded even if you're not the owner. All towing and storage costs are the responsibility of the vehicle owner. The owner of the impounded vehicle may recover from a driver, in any manner authorized by law, any amount the owner has paid to recover their motor vehicle.

An application to the Highway Traffic Board can be made to have a vehicle released early from impoundment in certain limited circumstances. If your vehicle was stolen at the time of the impoundment, please contact SGI at 1-844-855-2744 with your police file number as soon as possible.

Impaired driving

Drivers who are impaired by alcohol, drugs, or a combination of both may be subject to severe consequences. Consequences apply even if the driver is not found criminally impaired, but exceeded the provincial limits.

If a driver is found to have exceeded the provincial limit, the severity of the consequences are determined based on how many administrative suspensions have been issued in the past 10 years, and whether they are considered a new driver or an experienced driver.

If a driver is found to be criminally impaired, the consequences are more severe, and apply to all drivers.

New driver roadside administrative licence suspensions

New drivers caught with any detectable amount of alcohol or drugs will be suspended at roadside and face other consequences such as vehicle impoundment and mandatory ignition interlock.

There is zero tolerance for alcohol for new drivers, and zero tolerance for drugs for both new and experienced drivers.

New drivers are:

- 21 years of age and under
- Learner (Class 7)
- Class 5 Novice 1 and Novice 2
- Endorsement 6, M1, or M2 (while operating a motorcycle)
- No licence in the last five years
- Out of Country drivers (when equivalent Class cannot be determined)
- Restricted or Provisional drivers

New drivers who receive roadside suspensions and who are transporting passengers under 16 will receive an increased vehicle impoundment length. The chart below outlines the suspensions and consequences for new driver roadside administrative licence suspensions.

New Driver Roadside Administrative Licence Suspension Summary

		Number of Offences (Zero to .08 BAC and drugs) 10 year look-back		
		1st Offence	2nd Offence	3rd & Subsequent Offence(s)
Roadside Licence Suspension		60 days	120 days	18 months
Vehicle Impoundment		3 days	7 days	14 days
Passengers under 16		7 days	30 days	60 days
Required Program		Driving Without Impairment (DWI)*	Alcohol & Drug Education (ADE)*	Addictions assessment
Ignition Interlock	Installation Period	N/A	120 days	365 days
	Programs Must be Completed	N/A	Voluntary**	Mandatory
	Suspension Served***	N/A	60 days	365 days
Safe Driver Recognition Points		-4	-4	-4

* Must be completed within 120 days from the entry date of the suspension.

** Ignition interlock is voluntary to have installed. Once installed it becomes mandatory and must remain installed for the required period regardless of the number of days remaining in the roadside suspension.

*** This suspension period must be served before ignition interlock can be installed.

Experienced driver roadside administrative licence suspensions

Experienced drivers (any driver age 22 years and over that is not in the GDL program and holds a Class 5 or higher licence) who register a Blood Alcohol Content (BAC) level exceeding .04 to .08 and/or are impaired by drugs will lose their licence and face other consequences such as vehicle impoundment and mandatory ignition interlock.

If you hold an ignition interlock restricted licence, a special restricted licence or a provisional licence you will receive the same penalties as a new driver and should refer to the chart on page 152.

Experienced drivers who receive roadside suspensions while transporting passengers under the age of 16 will receive an increased suspension and vehicle impoundment length. The following chart outlines the suspensions and consequences for experienced driver roadside administrative licence suspensions.

Experienced Driver Roadside Administrative Licence Suspension Summary

		Number of Offences (.04 to .08 BAC and drugs) 10 year look-back		
		1st Offence	2nd Offence	3rd & Subsequent Offence(s)
Roadside Licence Suspension		3 days	21 days	90 days
Passengers under 16		7 days	30 days	120 days
Vehicle Impoundment		3 days	7 days	14 days
Passengers under 16		7 days	30 days	60 days
Required Program		Driving Without Impairment (DWI)*	Alcohol & Drug Education (ADE)*	Addictions assessment
Mandatory Ignition Interlock**	Installation Period**	N/A	N/A	365 days
	Programs Must be Completed	N/A	N/A	✓
	Suspension Served	N/A	N/A	90 days
Safe Driver Recognition Points		-4	-4	-4

* Must be completed within 120 days from the entry date of the suspension.

** Ignition interlock must remain installed for an accumulated 365 days. If removed, the driver will remain suspended until it is re-installed.

Indefinite roadside administrative licence suspensions

If you're charged with a criminal impaired driving offence you lose your licence immediately and face other consequences like vehicle impoundment. The immediate roadside licence suspension is indefinite and remains in effect until your charges are resolved in court. You may be eligible to reinstate your driving privileges early by voluntarily installing an alcohol-sensing ignition interlock device in your vehicle. To be eligible, your charge must be alcohol-related and you must serve at least 90 days of your indefinite suspension.

The chart on page 151 outlines the consequences for drivers who are convicted of a criminal impaired driving offence.

8.2 The Criminal Code of Canada

Certain driving behaviours are dealt with more severely or are considered to be sufficiently dangerous or objectionable to be dealt with under the Criminal Code of Canada.

The penalties and consequences for criminal driving offences are severe. In addition to the penalties under the Criminal Code, there are also provincial penalties. Under the provincial legislation the consequences include suspensions, reinstatement programs and financial penalties.

Some examples of Criminal Code driving offences are:

Impaired Driving Offences

Equal to or exceeds .08 BAC

It's an offence to drive or to operate a conveyance* when you have over 80 mg or more of alcohol per 100 ml of blood (or .08% per 100 ml). If your blood alcohol content (BAC) is over .08 you have committed a Criminal Code offence.

Impaired

Operating a conveyance while your ability to operate is impaired in any degree by alcohol or a drug or by a combination of alcohol and a drug is an offence.

** Defined as a motor vehicle, water vessel, aircraft or railway equipment.*

Exceeds drug

It's an offence to operate a conveyance when you have a blood drug concentration that is equal to or exceeds the blood drug concentration prescribed by federal regulation for that drug.

Combination alcohol and drug

It's an offence to operate a conveyance if you have a blood alcohol concentration and a blood drug concentration that is equal to or exceeds the blood alcohol and blood drug concentration prescribed by regulation for instances where alcohol and that drug are combined.

Operation – low blood drug concentration

It's an offence to operate a conveyance if you have a blood drug concentration that is equal to or exceeds the blood drug concentration that is prescribed by federal regulation for that drug and is less than the concentration prescribed for Exceeds Drug.

Mandatory Alcohol Screening

A police officer may demand a breath sample from a driver in the absence of having a reasonable suspicion that the driver has consumed alcohol.

Refusal

If a police officer suspects you are impaired they may demand that you provide a breath sample or samples of a bodily substance that, in the police officer's opinion,

are necessary to enable a proper analysis by means of an approved screening device or approved drug screening equipment. The police officer may also demand that you immediately perform physical coordination tests.

Knowing that a demand has been made for a sample, it's an offence to fail or refuse to comply without reasonable excuse.

Refusing to comply with a demand is an offence.

Administrative Consequences for Criminal Code Impaired Driving Offences

An indefinite licence suspension will be issued to any driver who is charged under the Criminal Code of Canada with an impaired driving related offence. The suspension will remain in effect until the charges are resolved in court. If the offence you are charged with is alcohol-related, you may be eligible to reinstate your driving privileges early by voluntarily installing an alcohol-sensing ignition interlock device in your vehicle. The vehicle being operated will also be seized under the Vehicle Impoundment program for a minimum of 30 days, to a maximum of 60 days if the BAC is .16 or greater, or if the driver failed to comply with a demand.

Further consequences will be applied if the driver is found guilty of the offence in court. The chart below outlines the consequences for impaired driving offences.

Impaired Driving Consequences

	Number of Offences (Over .08 BAC or Refusal) <i>10 year look-back</i>					
	1st Offence		2nd Offence		3rd & Subsequent Offence(s)	
Offence Type	.08 to .159 BAC ¹ or Impaired	.16 BAC ² and over or Refusal ³	.08 to .159 BAC ¹ or Impaired	.16 BAC ² and over or Refusal ³	.08 to .159 BAC ¹ or Impaired	.16 BAC ² and over or Refusal ³
Immediate Indefinite Suspension	✓	✓	✓	✓	✓	✓
Vehicle Impoundment	30 days	60 days	30 days	60 days	30 days	60 days
Education/Program ⁴	Driving Without Impairment (DWI)	DWI	Alcohol & Drug Education (ADE)	ADE	Addictions assessment	Addictions assessment
Safe Driver Recognition Points ⁴	Move to -20 or Minimum -10	Move to -20 or Minimum -10	Move to -20 or Minimum -10	Move to -20 or Minimum -10	Move to -20 or Minimum -10	Move to -20 or Minimum -10
Financial Penalty ⁴	\$1,250	\$2,250	\$1,250	\$2,250	\$1,250	\$2,250

¹ Alcohol or combination alcohol and drug, or over drug legal limit.

² Alcohol or combination alcohol and drugs.

³ Refusal means Failure or Refusal to comply with a demand.

⁴ Only applies if convicted.

Note: For any incident which results in injury or death, the financial penalty will be \$2,500.

Other Criminal Code driving offences

Criminal negligence

Driving with reckless disregard for life and safety is an offence. If you're charged and convicted of a criminal negligence causing bodily harm, the penalties are increased.

Dangerous driving

Failing to exercise reasonable care in the operation of a motor vehicle is an offence.

Failure to stop at scene of collision

If you're involved in a collision with a person, vehicle or cattle in the charge of a person, you must give your name, address, driver's licence number and insurance information to any other involved people and assist any injured people.

Drive while disqualified

If you drive while you're disqualified, you could face additional charges, vehicle impoundment, and other financial consequences. It's an offence under the Criminal Code to drive while disqualified.

Arrest

You may be arrested if you:

- operate an unregistered vehicle
- drive without a driver's licence
- fail to stop when signalled by police
- drive without care and attention or without reasonable consideration for others
- tamper with a vehicle
- fail to provide information when requested by police
- commit Criminal Code offences

You may be arrested if the police have reason to believe you will not appear in court to answer your summons.

Licence disqualifications

If you're convicted of any of the offences discussed in this section, your licence will be automatically cancelled and you will be disqualified from driving. The period of disqualification will be based on the number of Criminal Code convictions you have had in the last 10 years.

One conviction	1 year
Two convictions	3 years
Three convictions	5 years

In addition to these automatic provincial disqualifications, the court may issue an order prohibiting you from operating a motor vehicle on any street, road, highway or other public place anywhere in Canada for a period of time. You will not be allowed issue of a full unrestricted driver's licence until the expiration of the longer period, whether it is the automatic disqualification or the court order.

Reinstatement of driving privileges

If you're convicted of a criminal offence you may be eligible for early reinstatement of your driving privileges. Options for early reinstatement may include:

- Ignition interlock special restricted driver's licence
- Special restricted driver's licence

These options are issued on the provision that you have a zero tolerance for drugs and alcohol while driving. This means no detectable amount of alcohol or drugs in your system.

Ignition interlock special restricted driver's licence

The Ignition Interlock program is a remedial program for drivers who have received impaired driving suspensions or convictions. An ignition interlock device prevents you from operating a vehicle if you have alcohol in your body. A device is installed in the vehicle that is connected to the vehicle's ignition that checks for the presence of alcohol in the driver. The driver must blow into the machine to start the car, and continue to periodically blow into the device to keep the car in motion. If the device senses alcohol, the car will not start. If while in motion the device senses alcohol the horn will start honking and headlights will flash to draw attention to the vehicle. These cannot be stopped until the vehicle is turned off.

The ignition interlock special restricted licence is **mandatory** for the following:

- Your conviction was for impaired driving, driving while equal to or over the legal limit for alcohol or a combination of alcohol and drugs, or for failing to comply with a demand.
- You received a third roadside suspension within the last 10 years and it's alcohol-related. (**Note:** If you received your first two roadside licence suspensions as a new driver, those count towards the number of offences as an experienced driver.)

The ignition interlock special restricted licence is **voluntary** for the following:

- You received a second roadside licence suspension as a new driver within the last 10 years.
- You received an indefinite roadside administrative suspension for an alcohol-related Criminal Code offence and you've served at least 90 days of your suspension.

The device must remain in the vehicle until the ignition interlock suspension period ends. You cannot wait out your suspension period.

Eligibility and program duration

The Ignition Interlock program is mandatory for certain impaired driving offences, the length of the mandatory term depends on how many prior offences the driver has in the past 10 years, and the type of impaired driving offence.

You're not eligible for early reinstatement of your driving privileges by installing an ignition interlock device if you've been declared ineligible by a judge, your conviction is not alcohol-related, or because you've been convicted under the Criminal Code of Canada for any impaired driving offence causing bodily injury or death.

Special restricted driver's licence

A restricted driver's licence limits when and where you can drive. You may be granted a restricted licence if you demonstrate that:

- the licence suspension would cause you exceptional hardship
- allowing for a restricted licence would not be contrary to public interest

You're eligible to apply to the Highway Traffic Board for a special restricted licence if the following applies to you:

- Your conviction is non-alcohol/drug related and you have served the entire court-ordered prohibition period and completed the required educational program.
- Your conviction is alcohol/drug related and you have completed the required educational program and your mandatory ignition interlock term, and still must serve the provincial suspension.
- You paid the \$75 reinstatement fee.

8.3 Traffic tickets

When the police charge you with a violation, they'll issue a ticket indicating the offence you committed as well as the date, time and location. The ticket will also indicate where and when you are to appear in court. Some tickets, including those for stunting, racing and driving at excessive speeds, will result in an immediate roadside suspension.

For some less serious offences, the ticket will indicate the amount of the fine you must pay. If you choose to plead guilty, you may pay your fine voluntarily through the mail or online, if available.

You must appear in court to enter a not guilty plea. You'll then have a trial date set. You may want to consult a lawyer before entering a plea.

8.4 Driver Improvement Program

The Driver Improvement Program monitors the driving records of all Saskatchewan drivers. The program aims to make Saskatchewan roads safer for everyone by reducing the incidence of high-risk behaviours by motorists.

Impaired driving is one example of high-risk driving, but many motorists endanger the lives of others through behaviours that frequently cause motor vehicle collisions, including speeding, running red lights and stunting.

Under this program, drivers are assigned points every time they are convicted of a traffic offence or have an at-fault collision. Drivers who reach their maximum threshold of points are sent a warning letter to advise that tougher sanctions will follow should their driving record continue to deteriorate.

Drivers who continue their high-risk behaviour face consequences that include fines, driver's licence re-testing, driver's licence suspensions of up to six months and completion of a driver improvement training program.

For more information on the Driver Improvement Program, call 1-844-TLK-2SGI (1-844-855-2744).

8.5 Safe Driver Recognition

The Safe Driver Recognition (SDR) program rewards safe drivers with a discount on their vehicle insurance.

If you own or lease a vehicle registered in Class LV, PV or F (one ton model or smaller), you may be eligible to receive a discount on your vehicle insurance premium. That discount will apply to every qualifying vehicle you insure.

On the other hand, the program also ensures drivers who demonstrate risky behaviour pay their share in financial penalties - helping offset the costs of the discount for safe drivers.

Safety Rating Scale

Penalty Zone		Neutral		Safety Zone					
Points	Penalty per incident	Points	Discount	Good Drivers		Great Drivers		Safest Drivers	
				Points	Discount	Points	Discount	Points	Discount
-1	\$50	0	0%	1	2%	11	20%		
-2	\$100			2	4%	12		21	21%
-3	\$150			3	6%	13		22	22%
-4	\$200			4	8%	14		23	23%
-5	\$250			5	10%	15		24	24%
-6	\$300			6	12%	16		25	25%
-7	\$350			7	14%	17			
-8	\$400			8	16%	18			
-9	\$450			9	18%	19			
-10	\$500			10	20%	20			
Add \$50 for every additional Penalty Zone point to a maximum of \$1,000.*		↔		As long as your rating is zero or higher you will not pay a penalty.					

*Some Criminal Code convictions result in penalties up to \$2,500.

How it works

The Safety Zone – Discounts

For every year since 1995 that you have driven without an incident, you earn a safety point. Each point in the Safety Zone corresponds to a discount on your vehicle plate insurance, to a maximum of 25%.

Even if you don't own a vehicle, a positive rating in the Safety Zone is beneficial to you. It protects all safe drivers from financial penalties if they are involved in future incidents.

You only receive a financial penalty for an incident if it causes you to lose enough points to move you to the Penalty Zone on the scale. As long as you remain in the Safety Zone, you continue to receive some level of discount.

You're eligible for a Safe Driver Recognition discount on your registered motorcycle plates, if you get:

- To the Novice 2 stage of the Motorcycle Graduated Driver Licensing program and take an SGI -approved motorcycle training course, or
- Your full M Endorsement.

3 discount zones

- **Good Drivers Zone (+1 to +10)** - If you're in the Good Drivers Zone, you have earned enough safety rating points to receive a discount on your basic vehicle insurance. For each year you drive incident-free, you earn a safety rating point that gives you 2% off your basic vehicle insurance.
- **Great Drivers Zone (+11 to +20)** - If you're in the Great Drivers Zone, you have earned enough safety rating points to receive a 20% discount on your basic vehicle insurance, plus you have earned a cushion to shield you from losing some or all of your discount if you cause a collision or get traffic convictions in the future.
- **Safest Drivers Zone (+21 to +25)** - If you're in the Safest Drivers Zone, you have driven incident-free for more than 20 years. You earn an extra 1% discount for each additional year you drive incident-free up to a maximum discount of 25%.

The Penalty Zone – Financial penalties

Drivers lose points for unsafe driving - such as being at fault for a collision or certain traffic convictions and roadside suspensions. Driving disqualifications automatically move drivers to -20 or lower, regardless of where they were on the scale prior.

Financial penalties are assessed for incidents that result in a safety rating below zero.

- You're assessed a financial penalty of \$50 for each point you move in the Penalty Zone (capped at a maximum penalty of \$1,000).
- The further an incident moves you into the Penalty Zone, the more you pay for that incident. The maximum penalty noted above applies to most incidents, with the exception of certain Criminal Code convictions. The maximum penalty for a Criminal Code conviction is \$2,500, which is for offences that result in bodily injury or death.

Motorists are assessed the penalty immediately and have 90 days to pay the charge. These penalties are in addition to fines handed out by law enforcement for traffic convictions.

Moving out of the Penalty Zone

Each year of incident-free driving moves you one point back towards the Safety Zone. As long as you are moving towards the Safety Zone, you don't pay another financial penalty - you pay only your basic vehicle insurance premium. In other words, you don't pay your way out of the Penalty Zone - you drive your way out of the Penalty Zone through safe driving.

After three consecutive years of safe driving, drivers still remaining in the Penalty Zone automatically move out of the Penalty Zone and return to neutral (the starting point), and can begin to earn points towards a discount again.

For further information visit www.sgi.sk.ca or see SGI's Safe Driver Recognition brochure.

Fuel-efficient driving techniques

Safety should be your number one concern every time you get behind the wheel of a vehicle. The good news is that practising fuel-efficient driving techniques not only improves road safety, it also reduces fuel consumption and cuts exhaust emissions that contribute to climate change and urban smog. Depending on your driving habits and how often you drive, these basic techniques and useful tips could save you hundreds of dollars a year in fuel and maintenance costs:

- It's both safer and more fuel efficient to maintain a steady speed on a road. Accelerate smoothly when passing or merging with faster traffic and avoid hard braking. European tests have shown that aggressive driving, including frequent rapid acceleration and hard braking, can increase fuel consumption by approximately 40%.
- Drive at the posted speed limit. Lowering your highway cruising speed from 120 km/h to 100 km/h will reduce fuel consumption by up to 20%.
- Plan your trips to combine errands and to avoid traffic jams, steep hills, road construction, etc. Combining a number of short trips into one longer one allows your engine and drivetrain to reach peak operating temperature, which is not possible on trips of less than 5 km. Avoiding trouble spots shortens your travel time and reduces unnecessary idling.
- If you are driving a vehicle with a manual transmission, learn how to use it properly for maximum fuel savings. A tachometer can help you shift the transmission at the most fuel-efficient engine speeds (the owner's manual will indicate these speeds).
- If you have cruise control, use it for highway driving to maintain a constant speed. The exception is on hilly terrain, where it's a good idea to allow the vehicle's speed to drop slightly going uphill and then let gravity help you build up speed again (to a safe level) going down the other side.
- In summer, minimize your use of air conditioning. Operating an air conditioner in hot weather can increase fuel consumption by more than 20% in city driving. A more fuel-efficient option for staying cool is to open a window. However, at highway speeds, use your car's flow-through ventilation – open windows and sunroofs increase aerodynamic drag, which makes the engine work harder and consume more fuel. If you must use your vehicle's air conditioning, avoid running it continuously. Shut it off after the interior is cool or set the controls to a comfort level that allows the system to cycle.
- Check tire pressure at least once a month when the tires are cold (i.e., the vehicle has been stationary for at least three hours or has not been driven more than 2 km). If you have to drive more than 2 km to add air, check the tires before you leave and then add the amount of air that is missing from this reading. Inflate the tires to the recommended pressure, usually indicated on the car door, glove compartment or in the owner's manual. With proper tire inflation, your car will burn less fuel and be safer to drive. A vehicle with tires that are under-inflated by a total of 10 psi increases fuel consumption by 5%.

- Use a block heater in the winter to warm the engine oil and make cold starts easier on your engine components. Your vehicle's oil doesn't freeze when the temperature dips below 0°C, but it does get much thicker. This means your engine has to work harder and use more fuel. Use a timer to switch the block heater on two hours before you plan to drive. Proper use of a block heater can improve your vehicle's overall fuel economy by as much as 10%. Still, don't leave your block heater on overnight or your energy savings will disappear in a higher electricity bill.
- Follow the vehicle manufacturer's recommended operating procedures and maintenance schedule in your owner's manual. Regular maintenance such as oil and filter changes will not only prevent early degeneration of your vehicle's components, it will also keep them operating at their most fuel-efficient level. A clogged air filter can increase fuel consumption by up to 10%. Regular maintenance will keep your vehicle operating safely, save you money and, at the same time, help the environment.
- Remote car starters are handy on cold winter mornings, but don't start your car too soon. In most driving conditions, today's modern engines need less warm-up time even on cold mornings. Also, allowing your car to idle too long wastes gas and produces unnecessary exhaust emissions.
- Idling for more than 10 seconds, except in traffic, wastes more fuel than stopping your engine and restarting again. At the end of the day, stopping unnecessary idling will benefit the environment and save you money.

Index

A

Accelerating	103
Accelerator sticking	132
Aggressive driving	140
Airbags	98
Alcohol	142
Angle parking	109
Animals on the road	132
Arrest	156
Automatic transmission vehicles	104

B

Backing	105
Back-up cameras	108
Steering techniques	106
Before you drive	95
Design components for safety	96
Seating position	99
Vehicle familiarization	95
Bicycles	
Lanes	38
Sharing the road with	29
Blind spots	32
Blow-outs	131
Braking	124
Brake failure	131
Combined braking and steering	128
Emergency braking techniques	126
Four-wheel lock braking	125
Power steering or power brake failure	132
Threshold braking	125
Bus lanes	38

C

Cellphones	23, 141
Centre turning lanes	45
Change of name or address	11
Changing lanes	36
Child restraints	97
Cigarette smoke	141
Classified licence system	12
Closing time of two vehicles	116
Clutch	103
Neutral/clutch	103
Neutral/declutch	128
Collisions	134
Call the police	135
Check all injuries	135
Check for witnesses	136
Dangerous goods	136
Exchange information with other drivers	137
Failure to stop at scene of collision	156

Preventing potential collisions	94
Protect the scene	135
Report to SGI	137
Take photographs	136
What to do if you are in a collision	135
When to provide a report to police	136
Concept of gates	31
Construction signs	73
Controlled access highways	55
Corners	118
Coverage for multiple-vehicle losses	7
Coverage for specific single-vehicle losses	7
Criminal Code of Canada	154
Arrest	156
Criminal negligence	156
Dangerous driving	156
Driving while disqualified	156
Failure to stop at scene of collision	156
Ignition interlock special restricted driver's licence	157
Impaired driving offences	154
Licence disqualifications	156
Refusal	154
Reinstatement of driving privileges	157
Special restricted driver's licence	158
Criminal negligence	156
Crossing - railway	74
Crossing urban streets	56
Crossroad delineators	75
Cruise control	113
Curves	118
D	
Dangerous driving	156
Dense traffic	95
Design components for safety	96
Directional dividing lines	33
Ditches	130
Diverging Diamond Interchange	52
Drinking, drugs and driving	142
Driving while disqualified	156
Impaired driving consequences	155
Licence disqualifications	156
Refusal	154
Driver distraction	23
Driver education	16
Driver Improvement Program	159
Driver's licence	3
Change of name or address	11
Classified licence system	12
Driver Improvement Program	159
Driving while disqualified	156
Fake ID	4
Licence disqualifications	156
Mandatory driver education	16
Medical requirements	16
Producing driver's licence and registration	150

Reinstatement	157
Roadside suspensions	151
Drugs	145
Illegal	147
Prescription and over-the-counter drugs	145
Dust	140
E	
Electric kick scooters	30
Emergencies	126
Accelerator sticking	132
Animals on the road	132
Blow-outs	131
Brake failure	131
Combined braking and steering	128
Ditches	130
Drifting onto a soft shoulder	130
Emergency braking techniques	126
Emergency steering techniques	126
Headlight failure	132
Neutral/declutch	128
Power steering or power brake failure	132
Search patterns	89
Skidding	128
Where to look	126
While on the freeway	113
Emergency vehicles - sharing the road with	27
E-scooters	30
Eye use	88
Checking your gates in urban areas	93
Checking your gates on highways	91
Checking your instruments in urban areas	93
Checking your instruments on highways	92
Driving in dense traffic	95
Filling in the gap in urban areas	93
Filling in the gap on highways	91
Looking up in urban areas	92
Looking up on highways	89
Referencing down in urban areas	92
Referencing down on highways	91
Search patterns at night	93
Search patterns in emergencies	93
Search patterns in urban areas	92
Search patterns on highways and rural roads	89
Steer where you look	88
Sweeping highways with your eyes	91
Sweeping with your eyes in urban areas	93
F	
Fake ID	4
Farm equipment - sharing the road with	27
Fatigue	139
Filling in the gap	
Highways	91
Urban areas	93

Fines	152
Fog	140
Following distance - estimating	85
Freeways	
Emergencies on the freeway	114
Entering a freeway	113
If you miss an exit	114
Leaving a freeway	114
Restricted access freeways	113
While on the freeway	113
Funeral processions	30
G	
Gates	
Checking your gates in urban areas	93
Checking your gates on highways	91
The concept of gates	31
Golf carts	26
Graduated Driver Licensing Program	9
Gravel roads	119
Grid roads	119
Guide signs	75
H	
Hand over hand	102
Hand positions	101
Hand-to-hand	102
Hazards	80
Headlights	59
Failure	132
Heavy traffic	95
Highway driving	112
Highways	
Checking your gates	91
Checking your instruments	92
Controlled access highways	55
Cruise control	113
Divided highways	55
Driving to the left of centre	55
Emergencies on the freeway	114
Entering a freeway	113
Filling in the gap	91
If you miss an exit	114
Leaving a freeway	114
Looking up on highways	89
One-way highways	55
Restricted access freeways	113
Search patterns	89
Sweeping with your eyes	91
While on the freeway	113
Hill parking	110

I	
Ice and slippery surfaces	121
How to stop on slippery surfaces	123
Skidding	128
ID Requirements	15
Ignition interlock special restricted driver's licence	157
Illegal drugs	147
Illness	139
Impairing factors	
Aggressive driving	140
Cellphones	23, 141
Cigarette smoke	141
Drinking, drugs and driving	142
Fatigue	139
Fog, dust, heavy rain and poor visibility	140
Illegal drugs	147
Impaired driving	151
Personal stress and illness	139
Prescription and over-the-counter drugs	145
Students Against Drinking and Driving (SADD)	149
Information signs	76
Instruments	
Checking in urban areas	93
Checking on highways	92
Insurance	
Auto insurance in Saskatchewan	5
Extended Auto Insurance	8
Intersections	
Centre turning lanes	45
Highway	55
Left turns	41
Parking lots	58
Right of way	46
Right turns	40
Stopping positions	50, 51
IPDE method of driving	81
Decide	82
Execute	82
Identify	81
Predict	81
J	
Jaywalkers	55
K	
Knowledge tests	17
L	
Lanes	
Bicycle	38
Bus	38
Centre turning	45
Changing	36
Designation signs	67
Lane position	34

Lane selection	34
Passing	37
Laws	
Arrest	156
Complying with the law when driving	150
Criminal Code of Canada	154
Criminal negligence	156
Dangerous driving	156
Driver Improvement Program	159
Driving while disqualified	156
Enforcement	150
Failure to stop at scene of collision	156
Impaired driving offences	154
Impoundment	150
Licence disqualifications	156
Producing driver's licence and registration	150
Roadside suspensions	151
Rules related to vehicles	61
Stopping when signalled by police	150
Traffic tickets	158
Unsafe vehicles	150
Left turns	41
Licence plates	5
Insurance coverage	5
Your vehicle deductible	7
Lights	59
Failure	132
Looking up	
Highways	89
Urban areas	92
Low speed skills	104
Backing	105
Low speed manoeuvring	104
Steering techniques for backing	106
Low visibility and night driving	60
M	
Mandatory driver education	16
Medians	57
Medical requirements for driving	16
Medical scooters	56
Merging	113
Mirror adjustment	100
Motorcycles	57
Sharing the road with	28
Motorized wheelchairs	56
Mountains	119
Municipal roads	119
N	
Negligence - criminal	156
Neutral	
Neutral/clutch	103
Neutral/declutch	128
Night driving	60

Low visibility	60
Search patterns	93
No Fault Coverage	6
No-zones	25

O

One-way highways	55
One-way street	43
Operating in the United States.	16
Over-the-counter drugs	145
Overwidth vehicles - sharing the road with.	27

P

Parallel parking.	107
Parking	107
Angle parking	109
Back-up cameras	108
Parallel parking.	107
Parking on a hill	110
Signs.	66
Parking lots.	58
Passing.	36, 37, 115
Being passed.	117
Estimation of safe passing time	115
Estimation of the closing time of two vehicles	116
Lanes	37
The actual passing judgment	117
The safe/unsafe judgment	116
Pedestrian crossing signs.	66
Pedestrians.	55
Personal Auto Injury Insurance	8
No Fault Coverage	6
Tort Coverage	6
Phones - cellphones	23, 141
Potential hazards	80
Power lines.	136
Power steering or power brake failure.	132
Prescription drugs	145

R

Railway crossings	74
Rain.	140
Real hazards.	80
Reduced conflict intersection.	54
Referencing down	
Highways	91
Urban areas	92
Registration	5
Producing driver's licence and registration.	150
Regulatory signs	62, 64
Reinstatement of licence.	157
Report to SGI	137
Resource access roads	119
Restricted access freeways	113
Restricted Crossing U-Turn	54

Restricted driver's licence	158
Right of way	46
Construction or maintenance vehicles	49
Controlled intersections	48
Uncontrolled intersections	46
Zipper merge	49
Right turns	40
Roadside suspensions	151
Road test	18
A road test will be rescheduled if	19
Before the examination	17
Preparing for your road test	17
You will fail the road test if you	20
Roundabouts	51
Rules related to vehicles	61
Rural roads - search patterns	89
S	
SADD	149
Safe Driver Recognition	160
Safe passing time	115
Safety	
Design components	96
Unsafe vehicles	150
Safe/unsafe judgment	116
School buses - sharing the road with	27
Search patterns	
Emergencies	93
Highways and rural roads	89
Night	93
Urban areas	92
Seatbelts	96
Seating position	99
Seizure of vehicles	150
Shared bicycle lanes	39
Sharing the road	24
with bicycles	29
with emergency vehicles	27
with E-scooters	30
with farm equipment and overwidth vehicles	27
with funeral processions	30
with large trucks	24
with motorcycles	28
with school buses	27
with snowmobiles, ATVs and golf carts	26
with snow plows	26
with tow trucks	30
Shifting	103
Shoulder - drifting onto	130
Signalling	35
Signals - traffic	77
Signs	62
Construction signs	73
Crossroad delineators	75
Guide signs	75

Information signs	76
Lane designation signs	67
Parking signs	66
Pedestrian crossing signs	66
Railway crossings	74
Regulatory signs	62, 64
Six basic sign shapes every driver must know	62
Standard sign colours	64
Turn control signs	68
Warning signs	69
Slippery surfaces	121
How to stop on slippery surfaces	123
Skidding	128
Smoke - cigarette	141
Snowfalls	123
Snowmobiles - sharing the road with	26
Snow plows - sharing the road with	26
Speed	22
Choosing the right speed	60
Standard (manual) transmission vehicles	103
Steering	101
Backing	105
Combined braking and steering	128
Emergency steering techniques	126
Hand over hand	102
Hand positions	101
Power steering or power brake failure	132
Steer where you look	88
Stopping and parking	24
Stopping positions	50
Stress	139
Students Against Drinking and Driving (SADD)	149
Survival - winter	124
Sweeping with your eyes	
Highways	91
Urban areas	93
T	
Tests	
Knowledge	17
Road	18
Vision	18
Tickets	158
Time	
BAC and time	144
The key to judgment	83
Using time to estimate your following distance	85
Tire blow-outs	131
Tort Coverage	6
Tow trucks - sharing the road with	30
Traffic lanes	34
Traffic Safety Act	150
Arrest	156
Enforcement	150
Impoundment of vehicles	150
Producing driver's licence and registration	150

Roadside suspensions	151
Stopping when signalled by police	150
Unsafe vehicles	150
Traffic signals	77
Traffic signs	62
Construction signs	73
Crossroad delineators	75
Guide signs	75
Information signs	76
Lane designation signs	67
Parking signs	66
Pedestrian crossing signs	66
Railway crossings	74
Regulatory signs	62, 64
Six basic sign shapes every driver must know	62
Standard sign colours	64
Turn control signs	68
Warning signs	69
Traffic tickets	158
Train crossings	74
Trucks - sharing the road with	24
Turning	40
Centre turning lanes	45
Control signs	68
Corners	118
Left turns	41
Right turns	40
Two-point turns	111
U-turns	110
Turn signals	35
Two-point turns	111
U	
Unsafe vehicles	150
Urban streets	
Checking your gates	93
Checking your instruments	93
Crossing	56
Filling in the gap	93
Looking up	92
Referencing down	92
Search patterns	92
Sweeping with your eyes	93
U-turns	110
V	
Vehicle	
Coverage for multiple-vehicle losses	7
Coverage for specific single-vehicle losses	7
Familiarization	95
Impoundment	150
Personal Auto Injury Insurance	8
Registration	5
Rules related to	61
Unsafe vehicles	150
Vehicle registration	5

Visibility
 Night driving and low visibility 60
 Poor visibility 140
 Vision test 18

W

Warning signs 69
 Wheelchairs 56
 Whiteouts 123
 Wildlife (see "Animals on the road"). 132
 Winter driving. 120
 Driving on slippery surfaces 121
 First snowfalls 123
 How to get moving 123
 How to stop on slippery surfaces 123
 Preparing to see and to be seen 121
 Preparing your vehicle. 120
 Survival 124
 Temptations to resist 123
 Whiteouts. 123
 Work zone 22, 73

Z

Zipper merge 49

