



*Restricted to
Nunavut*

Driver's Manual

Motor Vehicles Division,
Department of Economic Development & Transportation,
Government of Nunavut

P.O. Box 10, (NCC Building),
Gjoa Haven, NU, X0B 1J0

Phone: (867) 360-4615
Fax: (867) 360-4619



Economic Development and Transportation

FOREWORD

This Manual is for Nunavut residents who wish to apply for a driver's licence that will allow them to drive only in Nunavut. If you are this type of applicant, then your driver's licence will have a special statement on it called "B" or a "G" endorsement. This means you will be allowed to drive in Nunavut only, or, drive only 100 kilometres from your home community.

Those who wish to obtain a driver's licence that will allow them to drive outside Nunavut should check the Nunavut Driver's Manual. Those who wish to obtain a learner's licence to drive a commercial vehicle should review the Professional Driver's Handbook and/or the Air Brake Manual for those who will be driving a vehicle equipped with air brakes.

This Manual will help you to drive safely and help you with your driver's test. It will help you understand what you must do as a responsible Nunavut driver to make sure the roads are safe – for you, your children and other drivers.

As you first learn to drive and continue learning, remember that the safety of our children is in your hands. As you drive through your communities, through their roads, their school zones and playground zones, their parking lots, be on the

look-out for children. Care at the wheel will ensure safety and the future of Nunavut citizens.

This Manual will give you:

- 1 information that is easy to read
- 2 information to help you drive safely in Nunavut
- 3 information on all the classes of driver's licences
- 4 information on the rules of the road and what you must do as a safe driver.

Keep this manual in your car or truck. You will be able to check on information you are not sure of. This manual is an easy read version, so you may want to check the more complete version for more information.

Motor Vehicles Division,

*Department of Economic Development & Transportation,
Government of Nunavut,*

P.O. Box 10, (NCC Building),

Gjoa Haven, NU X0B 1J0

Phone: (867) 360-4615

Fax: (867) 360-4619

TABLE OF CONTENTS

Classes of Nunavut licences.....	3
Class 1-4	3
Class 5-7	4
The Driver’s Exam.....	5
What You Know About Driving	
Vision Test	5
How Well Do You Drive On The Road	
Waiting Periods Between Tests	6
Language Of The Test	7
Renewing Your Licence	7
Motor Vehicle Registration And Insurance.....	9
Registration of a Vehicle.....	9
Starting Out.....	11
Good Driving Practices	11
Rules Of The Road.....	16
Signs	16
Right Of Way.....	17
Intersections With No Signs or Lights.....	17
Four Way Stop Intersections.....	17
Approaching An Intersection.....	18
No Markings On The Road.....	18

Left Turn	18
Emergency Vehicles	18
Funeral Processions	18
Blind Persons	18
Crosswalks	19
School Playgrounds Zones	19
School Buses.....	19
Signalling	19
Shoulder Checks	19
Turning	21
Right Turns	21
Left Turns.....	22
Safe Driving Practices	25
Following Distances.....	25
Passing.....	26
Stopping And Parking	29
Backing Up.....	35
Speeding	36
Other Things To Watch For	38
Hazardous Driving Conditions.....	39
Gravel	39
Dust	39
Flying Rocks And Stones	40
Loose Gravel.....	41
Ice, Sleet And Snow Conditions	42

Night Driving	44
Drowsiness Or Fatigue	47
Curves And Hills.....	48
Hydroplaning	48
Rain.....	49
Snowplows And Maintenance Machinery.....	49
Driving Emergencies	50
Blow-Out.....	50
Skidding.....	50
Wet Brakes	51
Direct Collision Course.....	52
Drugs And Alcohol	54
Motorcycles.....	56
Special Provisions	56
Special Rules	57
Motorcycle Driving Tips	58
Reporting Accidents	59

CLASSES OF NUNAVUT LICENCES

CLASS 1

FOR DRIVING:

- a) Large Trucks and tractor trailers and smaller commercial trucks (Class 1 and 3)
- b) Large and small buses, taxis and ambulances (Class 2 and 4)
- c) Car or personal truck
- d) As a motorcycle learner (Class 6)

CLASS 2

FOR DRIVING:

- a) Large and small buses, taxis, ambulances (Class 2 and 4)
- b) Commercial trucks, not including tractor trailers (Class 3)
- c) Cars and personal trucks (Class 5)
- d) As a learner (Class 1 and 6)

CLASS 3

FOR DRIVING:

- a) Smaller commercial trucks with 2 or more axles with gross weight of more than 4500 kg
- b) Trucks and trailers, such as a Tandem dump truck, with a total gross weight for the two of less than 4500 kg
- c) Small busses that carry less than 24 people, taxis, ambulances (Class 4)
- d) Car and personal trucks (Class 5)
- e) As a learner (Class 1, 2 or 6)

CLASS 4

FOR DRIVING:

- a) Buses which seat 24 people or less
- b) Taxis, ambulances
- c) Cars and personal trucks
- d) As a learner (Class 1, 2, 3 or 6)

CLASS 5

FOR DRIVING:

- a) Cars, small trucks with 2 axles only, such as vans, half ton and ton trucks that have a gross weight of less than 4500kg
- b) As a learner (Class 1, 2, 3, 4 and 6)
- c) A tractor, grader, loader, shovel, roller, scraper or other road building and construction vehicles with 2 axles only (but a grader or 3 axle compactor is included)

CLASS 6

FOR DRIVING:

- a) Motorcycles
- b) As a learner for class 5

CLASS 7

FOR DRIVING:

As a learner, any vehicle in Class 5 or 6

NOTE:

You must be 15 years old to get a Class 7 licence. For Class 5 or 6, you must be 16 years old. To drive a school bus, you must be 18 years old, have a medical examination and you must already have a class 2 or 4 licence, depending on the size of bus you want to drive.

THE DRIVER'S EXAM

There are three things that will be tested.

- 1 What you know about driving (written part)
- 2 How well you see (a vision test)
- 3 How well you drive on the road (road test)

WHAT YOU KNOW ABOUT DRIVING

This test has two parts:

- 1 You must know the rules of the road and how to drive safely.
- 2 You must know the signs you see on the road and what they mean.

If you do not pass one of these two parts, you will have to write that part again.

VISION TEST

Everyone must be able to see to drive. If you need glasses to pass the vision test, then you will have to wear them all the time when you drive. You must also be in general good health.

HOW WELL YOU DRIVE ON THE ROAD

The road test is used:

- 1 To see if you can drive the vehicle properly and safely
- 2 To show what you might need more practice on

The vehicle you are tested in must be the right one for the type of licence you want. The vehicle must be in good running order. You must make sure that the following parts are working well:

- Steering wheel
- Brake
- Emergency brake
- Windshield wipers
- Muffler
- Horn
- Headlights, signals, parking lights
- Tail lights
- Other lights as needed
- Tires
- Speedometer

The road test will check you on:

- 1 Starting out
- 2 Stopping
- 3 Turning
- 4 Obeying signs
- 5 Lane driving
- 6 Going through intersections with and without signs or signals
- 7 Backing up
- 8 Being ready for things that might go wrong
- 9 Your manners towards other drivers and pedestrians

You may NOT be allowed to take the test if:

- You are late
- You do not have insurance and the vehicle registration with you

- There is no license plate on the car or truck
- The test vehicle is not in safe condition
- The inside of the test vehicle is not clean
- You do not have the right kind of vehicle for the class of license you want to be tested for
- You are not medically fit or do not have adequate eyesight
- You show signs of drug or alcohol abuse
- You show that you do not have the driving skills and that you would be a dangerous driver

When you are finished the test, any mistakes you made will be explained to you. If you do not pass the test, you can set another time to be tested again. You will have to pay another fee before you can take the test again.

WAITING PERIODS BETWEEN TESTS

A First time driver must have done four weeks of practice driving with a learner's permit before taking the driver's exam.

The practice time for a person who wants a Class 7 learner's permit and wants to go on to a Class 5 or 6 licences is at least four weeks. Anyone who does not pass the Class 5 or 6 road test must practice for a two-week period. Where a person does not pass the road test for a second or third or more times, the practice period will be set by the driver examiner.

A person with an expired driver's licence or a person coming off a licence suspension may not have to take practice period, but this will be set by the driver examiner. The same is true for a person from another country that has a Class 5 or higher licence.

LANGUAGE OF THE TEST

For those cannot read and understand the written test, the driver examiner may give you a spoken test. For those who cannot speak the language, the use of an interpreter for the test is allowed. You should try to find someone to interpret for you and the driver examiner will keep an eye on the interpretation.

RENEWING YOUR LICENCE

Your licence is good for about five years and it runs out on your birthday. That means every 4 to 5 years, you will need renew it. To renew your licence, you must apply in person. You can renew it for up to a year after it runs out without having to take a test. If you lose your licence or it is destroyed, get a new one by applying to the head office as soon as you can. You will have to show proper ID to get a new or replacement licence, but do not drive after the date the licence expired as that's against the law and you could be charged.

Lost Driver's Licence

If you lose your driver's licence, you will have to let the RCMP know by filing out a "Declaration of Lost Licence" form.

Change of Name or Address

Tell the office that gave you the licence of any change in your address or name. Bring in your current licence and there will be no charge to get the change done.

Changes in your Health

If you develop a health problem that affects how well you are able to drive, you must let the Motor Vehicles Division know about it.

IMPORTANT

- You must NOT drive if your licence is suspended (the police or courts have taken it away because of a serious offence), or you have a medical condition that can make you an unsafe driver. You can get a large fine or go to jail if you do.
- You must sign your driver's licence.
- You must carry your driver's licence with you whenever you drive.
- You must not drive after your licence has run out, unless you renew it.
- You must not put wrong information on the application for your driver's licence.

MOTOR VEHICLE REGISTRATION AND INSURANCE

REGISTRATION OF A VEHICLE

Each motor vehicle must be registered and have insurance before it is allowed to use the roads and highways.

Licence Plates and Registration Stickers

A new licence plate in the famous polar bear shape is given when the vehicle is first registered. A registration sticker is issued at the same time and also each year and it must be stuck to the licence plate. This will make sure that police and others know your vehicle is properly registered.

Insurance

As long as your motor vehicle is registered, it must have the proper insurance. Your insurance policy must be in the amount of at least \$200,000 to cover you in case there is an injury or damage to property if you have an accident. You must have proof of the proper insurance before you can register the vehicle.



Renewal of Registration

Each year you must renew your registration before it runs out. The renewal date, by month, is on the sticker on your registration card. You can apply at the office that gave you the registration. You must turn in your old registration card and show your insurance card, fill in the form and pay the fee.

Registering a new vehicle

When you register a brand new car or truck, you must have with you your bill of sale and the New Vehicle Information Statement (NVIS) given by the dealer. You must also have insurance.

The same name must appear on all three documents, the bill, the NVIS and insurance, whether it is the name of a person or a company or even two persons jointly.

Change of address or name

You must tell the nearest office within 15 days of any change of address or name. If you change your name, bring your marriage certificate or other legal document that shows the change. Also be sure to bring in your current registration form for the change to be done.

Selling or trading-in your vehicle

You keep your licence plates if you sell or trade in your car or truck. But you can only put them on another car or truck if you have proper insurance on it. You must get another registration card within 14 days of putting the plates on another car. Be sure that if you move your plate to another vehicle, that vehicle is used for the same purpose. For example, a plate from a private vehicle must go on to another private vehicle must go on to another private vehicle. It cannot be moved to a commercial vehicle, for example. If you are not going to use your plate once you have sold your car, you must return it to the Motor Vehicle Department.

Buying a vehicle already registered

When you buy a vehicle that is already registered, have the seller sign over the registration and give it to you. There is a section on the registration card that must be signed. Then take it to the registration office, with your bill, your insurance card and have the vehicle registered in your name.

STARING OUT

GOOD DRIVING PRACTICES

Becoming a safe driver depends on good reflexes, good judgement and good will towards other drivers. You must also deal with situations that might arise quickly. Driver error is the cause of most accidents and this manual will help you avoid them. You can earn the basics of driving by studying this manual, but you must also keep learning as you continue driving.

You and Your Vehicle

Your routine check before you drive should include the following:

- tires and tire air pressure
- headlights and turn signals
- oil and windshield wiper fluids and fan belts, radiator and coolant hoses

Driving Position

Before you drive away, you should be properly seated. Sit up straight and well back in the seat. You must do up your seat belt. Move your seat so your feet reach the pedals easily.

Wear comfortable flat shoes that allow you to feel the pedals. You should grip the steering wheel lightly but firmly. If you have to strain your body to turn the wheel, move closer. Never drive without first making sure the seating position suits you personally and then check the mirrors both inside and outside.

Instruments and Visual Controls

Know your car's instrument panel. Know what each button and control does and where it is, so that you will be able to reach it without taking your eyes off the road. In winter, the heater and defroster controls should be closed at night so that snow and moisture don't enter the system. Otherwise your windshield will fog up when you start off in the morning.

Attitudes

Safe driving means that you give driving your full attention. Keep your mind on the road so that you are not a danger to yourself and others on the road. Don't do things that might distract you from driving, don't eat or drink, light a cigarette, change a tape or CD or use a hand held cell phone. Use extra care if you are driving with a pet in the car.

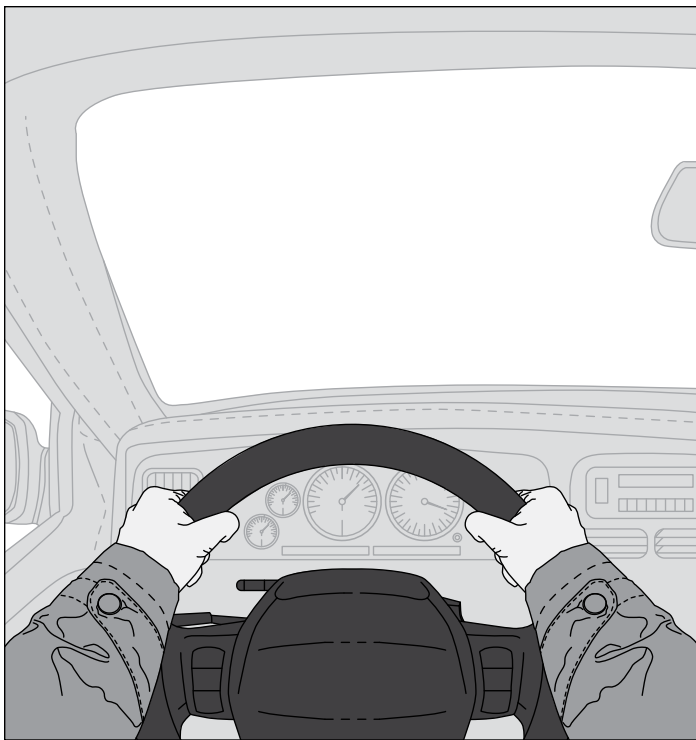

Steering Method

If you are seated properly, steering your vehicle should be easy, provided your hands are used properly. Put your hands on top half of the wheel, well spaced apart and not on the inside spokes of the wheel.

Vehicle Equipment

Good driving habits are not enough if your car or truck is not in a safe and road-worthy condition. Keep the following equipment in safe working order:

Brakes

The law says you must have proper foot brakes and an emergency or handbrake. You must keep the brakes in good working order at all times.

Lights

All motor vehicles must have two headlights, two red tail lights and red brake lights that work when your foot touches the brake. Motorcycles must have only one each. You must always drive with headlights on. If you do not have daytime running lights that come on when you start your car, get into the habit

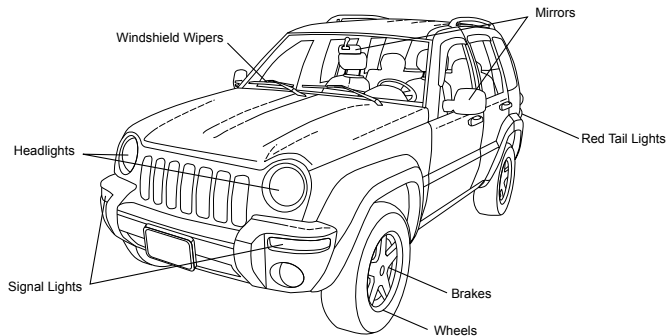

of checking that your lights are on when you start off and off when you finish driving.

Horn

The law says you must have properly working horn. It should be used only when necessary. If you honk so that it makes a disturbance, you could be charged.

Muffler

All motor vehicles must have a muffler in a good working order in order to keep down noise.

Windshield and Wipers

You must keep your windshield in good condition and free of stickers and posters that might obstruct your view. Cracks in the windshield should not block your view. If you are going to have your windows tinted, check the rules about how dark they can be. Your wipers must be operating properly.

Mirrors

Each vehicle must have a mirror that gives the driver a clear view of the roadway to the rear. If the vehicle has a load that obstructs the driver's view or if is towing a trailer, it must all be in good working order.

Other Equipment

The law also says that tires, the speedometer and odometer, the temperature and oil pressure gauges must all be in good working order.



Inspection of Equipment

A police officer, or other motor vehicles officer, can stop you and inspect the equipment in your vehicle. If there is a problem, the officer can order you to have the part fixed right away. The officer can also order the vehicle off the road and have it towed

away immediately or, order that it not to be driven on roads until it is properly fixed.

Seats Belts

The law says that all drivers and passengers must wear seat belts and that child car seats be used for all small children. Seat belts are very important. You can obey all the rules and suggestions on how to avoid accidents, but using a seat belt is one of the best ways to avoid getting hurt or being killed. If you have both shoulder belts and lap belts, be sure to use both.

Seat belts keep you from being thrown of the vehicle if there is a sudden stop or crash. They prevent the persons wearing them from hitting the inside of the car, the windshield or other passengers inside the car. By keeping the driver behind the wheel and in control of the car, they can prevent a crash.

If you think that seat belts are dangerous if you fall into water, think about this. Only 1 out of 200 accidents involve falling into water. The seat belt keeps you conscious and unhurt so that you can get out of the car. Since most accidents happen when cars are going less than 65km per hour, and close to home, belt up even when driving in town. Use seat belts all

the time, no matter how short the trip, whether you drive in or outside of town and make sure passengers do also. Your seat belt is your lifebelt!

Air Bags

These must already be in the car or they be put in by someone who is authorized to do so. Rebuilt or recycled airbags have caused problems in other provinces, so avoid these.

Children in the Car

Never hold a child on your lap because the force of a crash can pull the child from your arms. A child can also be crushed if the adult is not buckled up. Make sure that you set a good example for children. Get into the seatbelt habit from moment you learn to drive. Make sure your children buckle up or buckle up for them. If your child is too small for a seat belt (under 40 lbs), then choose a child car seat that is the right size and the type that is approved type. Try to keep children from making noise or movements that may distract you from driving.

Winter Preparation

Check the battery, make sure brakes are adjusted, check windshield wipers, heater and defroster, and anti-freeze levels to get ready for winter. Change to winter tires.

Child Car Seats

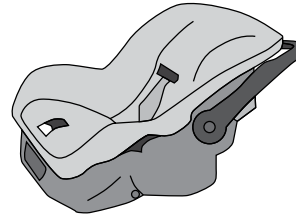

3-9 kg (5-20 lbs)

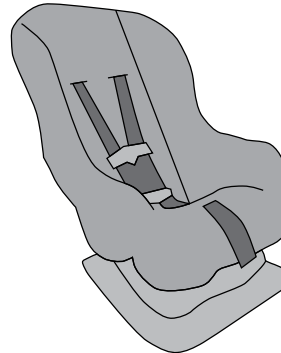

18 kg + (40 lbs +)

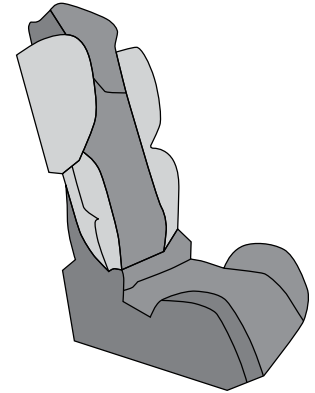

9-18 kg (20-40 lbs)

RULES OF THE ROAD

SIGNS

There are five basic shapes to the signs that you will see on the road.

The “must obey” signs tell the driver about laws or rules for different parts of the road. You commit an offence if you disobey these signs. They tell you when you must stop, slow down or how fast you may go.

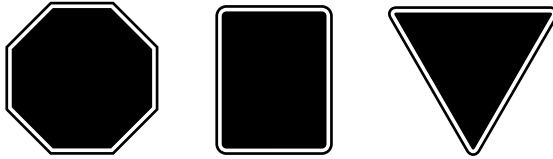

Warning signs alert you unsafe conditions that are coming up on the roadway. For example slow down or watch for the curve in the roadway.



Pedestrian signs tell you there are lots of children in the area and that you should slow down, be careful and be prepared to stop.

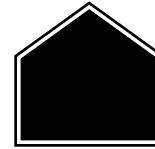

TRAFFIC SIGNALS

- Red – stop
- Yellow – drive carefully and do not go into the roadway
- Green – go, but even if there is a green light, check for other vehicles

When used together they operate in the following order: green, yellow, red. They can also be used on their own. There are no traffic lights in Nunavut yet, but you may find some soon.

RIGHT OF WAY

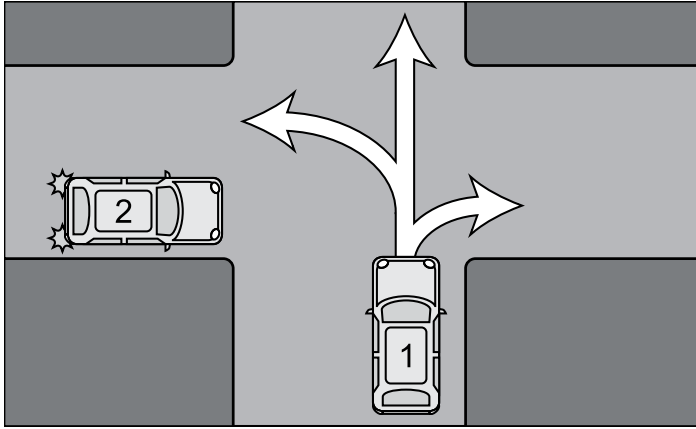

INTERSECTIONS WITH NO SIGNS OR LIGHTS

When two vehicles come to an intersection with no stop signs or lights at the same time, they should both slow down. The vehicle on the left must let the one on the right go first (have the right of way). Always check to your right to allow that other vehicle to go first. This is a rule that is not always obeyed, so drive carefully, even if you are the one with the right of way. Enter the intersection when it is safe to do so.

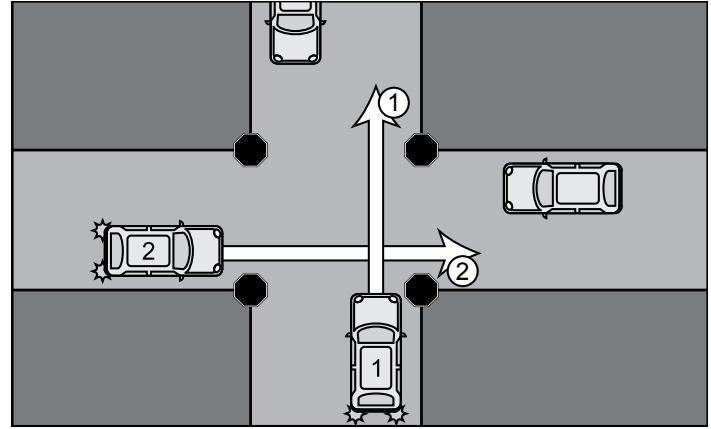

FOUR WAY STOP INTERSECTIONS

Where there are four stop signs at an intersection, the first vehicle to arrive and complete a stop has the right of way. That vehicle can continue when it is safe to do so. Vehicle arriving at a four-way stop proceed through the intersection in the order in which they arrived, but only when it is safe to do so.

APPROACHING AN INTERSECTION

Many dangers come up at intersections, but if you know the right-of-way rule you can avoid them. Don't depend on other drivers to always obey rules. To avoid accidents at intersections, follow these practices:

Never enter an intersection at a speed that is too fast to make a safe stop. You should drive at a speed at which you can make a stop safely, should you need to do so.

Don't think that you have the right of way, even if the traffic signs reinforce it. Always look left and right before entering an intersection. A vehicle can appear quickly. Look for and expect that another driver might run the stop sign.

Do not expect that other drivers will signal their turns or even make their turns correctly.

NO MARKINGS ON THE ROAD

If you turn onto a street or out-of-town road from a driveway, a private road or alley, always give the right-of-way to the main road traffic and walkers. Let them go first. While there are now no road markings in Nunavut, these may come soon.

LEFT TURN

When making a left turn at an intersection, always give the right-of-way to the traffic coming straight through the intersection. Make your turn when the on-coming traffic is clear and it is safe to do so.

EMERGENCY VEHICLES

Always give the right-of-way to police cars, ambulances and fire trucks if their light or siren is on. Pull over to the right side of the road as far as it is safe to go, or clear the intersection, and stop. Do not drive closer than 150m (500') behind a fire truck.

FUNERAL PROCESSIONS

To show respect, you should allow a hearse to pass without interference.

BLIND PERSONS

Drive carefully when you see a blind person (someone with a white cane or a Seeing Eye dog), or someone who is in a wheel chair or on crutches, stop for them when they wish to cross the road.

CROSSWALKS

When you approach a cross walk, always be on the lookout for people. If there is someone on the crosswalk, you must stop your vehicle and continue driving only when the walker has safely crossed the road. There are two types of signs that tell you there is a crosswalk:



It is against the law to pass a vehicle that is stopped at a crosswalk.

SCHOOL PLAYGROUND ZONES

When you see a sign that a school or playground is in the area, you must slow down and watch for children. The sign will show the maximum allowable speed but drivers must be very careful. The posted speed is not always the safest and drivers must be aware of conditions. Children are very unpredictable and may not stop to check traffic before crossing the street or chasing a ball.

SCHOOL BUSES

When you approach a school bus from either the front or the back, and it has its lights flashing, you must stop before reaching the bus. Do not keep driving again until the lights stop flashing.

SIGNALLING

The law says that you must signal to other drivers when you are going to enter traffic, slow down, stop or turn. You can use your vehicle's turning lights or your arm and remember to check your mirror. The hand signals look like this:

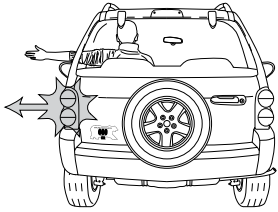

Left Turn

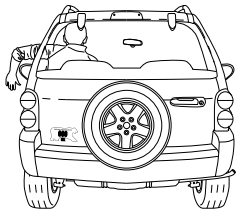

Stop or Slowing Down

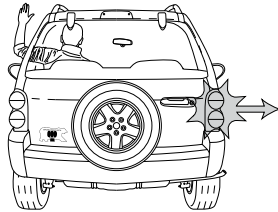

Right Turn

SHOULDER CHECKS

When you are backing up your vehicle, or changing lanes, or passing, you must check for traffic all around you. Your rear view mirror may not be enough to do this check. You should turn your head over your shoulder to do a complete check. This is especially true of the left side of your vehicle, where you have a “blind spot”. That means a car may be coming up on the left side of your vehicle, which you don't see in your mirror. A shoulder check is needed.

TURNING

The following are good practices to follow when you make the turn:

- 1 Decide where you want to turn before you actually make the turn because turning at the last second is dangerous.
- 2 Look behind you and to both sides to see where other vehicles are, before you make the turn. Ensure there are no pedestrians, cyclists or other vehicles. Watch out for your blind spots.
- 3 Even though lanes are not marked on the road, move to proper lane long before you turn.
- 4 Signal your turn well before you actually make the turn. If you use a hand signal, hold the signal until you are ready to turn and then use both hand for steering.
- 5 Make your turn at a speed low enough to keep your car under control. This will depend on the road conditions as well.
- 6 Make your turn as shown in the picture (on the next page).
- 7 Finish the turn in the proper lane.

Things that make turning unsafe:

- 1 Turning without making sure it is safe.
- 2 Not watching for vehicles coming from behind and wanting to pass.
- 3 Giving a short, late or no signal.
- 4 Starting the turn too soon (called cutting the corner).
- 5 Not staying in the proper lane.
- 6 Not giving walkers the right of way.
- 7 Turning too fast for good control.
- 8 Turning too fast when road conditions are not good.

RIGHT TURNS

Always stay in the right-hand lane and don't swing your car to the left first. Straighten out as soon as you have entered the other road.

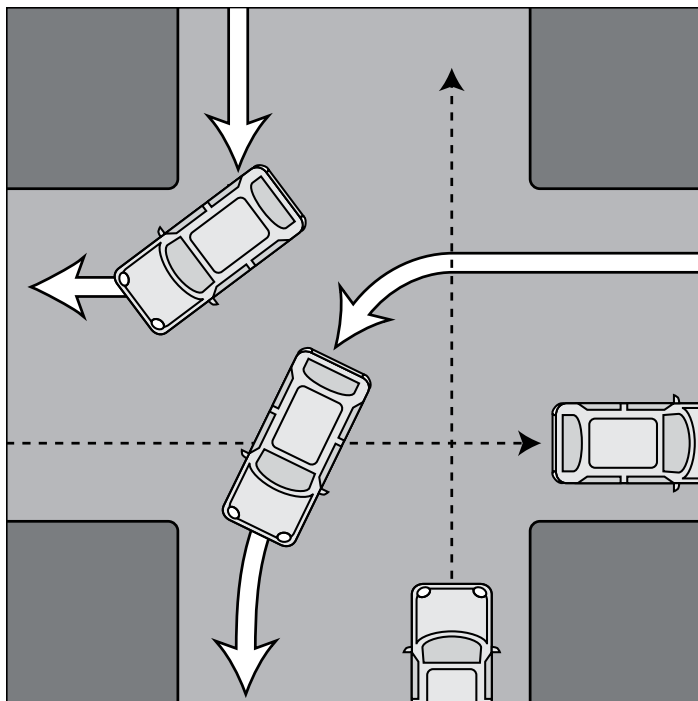

Don't turn until it is safe

LEFT TURNS

You should be in the proper lane well before you want to make a left turn and use the proper turn signal. Let the traffic coming from the opposite direction go first. Pedestrians in crosswalks must finish crossing. Don't turn until it is safe.

When turning, watch for:

- Vehicles, including ATVs, snowmobiles and cyclists, coming at you from the other direction
- Pedestrians in the crosswalk
- Vehicles making a right turn onto the same street as you are turning onto that are making their turn too wide
- Vehicles travelling on the same street you are turning onto.

Left turns are more difficult because you need to turn differently depending on the type of streets. In addition to the usual left turn described and shown in the picture (left), there are three others:

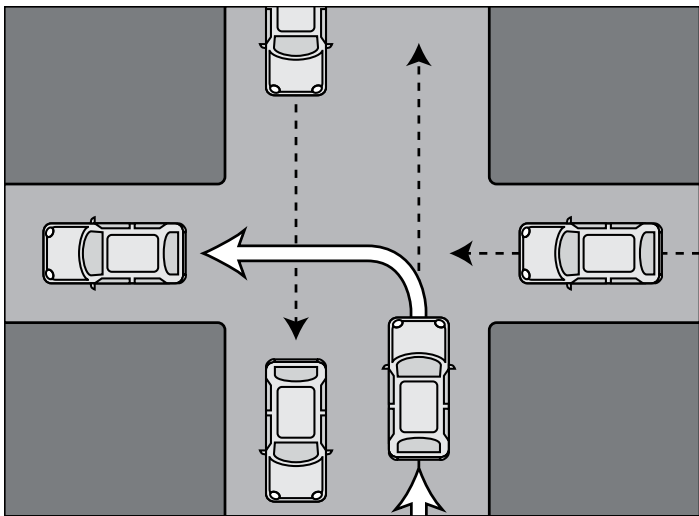

A LEFT TURN FROM A TWO-WAY STREET TO A ONE-WAY STREET

Make your turn signal well back from the intersection and look behind you for traffic. When clear, move to the centre lane. Look ahead and to the left and right. Make your turn as soon as you start into the intersection. Turn into the closest curb lane on the one-way street.

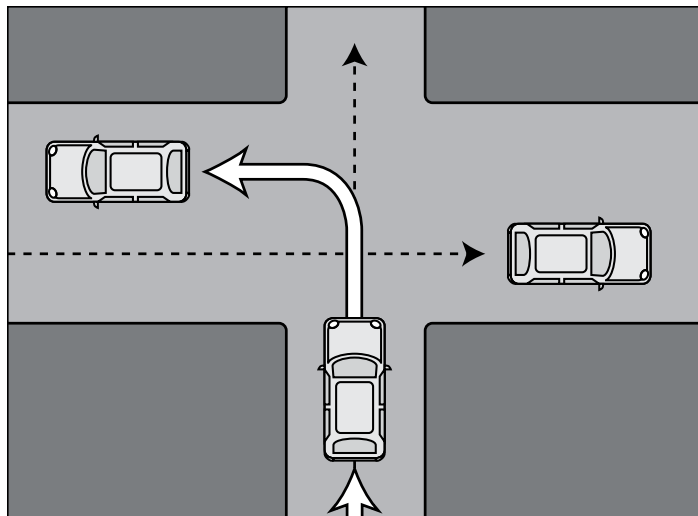

A LEFT TURN FROM A ONE-WAY STREET TO A TWO-WAY STREET

Make your turn signal well back from the intersection and look behind you for traffic. When clear, move to the left side of the one-way street. Look ahead and to the left and right. Then turn into the lane so that the centre line of the street you are turning onto is on your left.

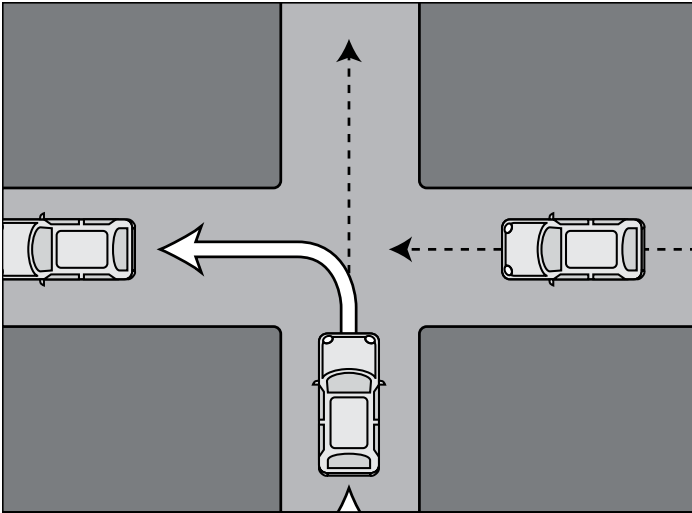

A LEFT TURN FROM A ONE-WAY STREET TO A ONE-WAY STREET

Make you turn signal well back from the intersection. Move to the left side of the street when it is clear. Look ahead and to the left and right. Turn from the left curb lane into the left-hand lane of the one-way street, making sure that exits are clear.

SAFE DRIVING PRACTICES

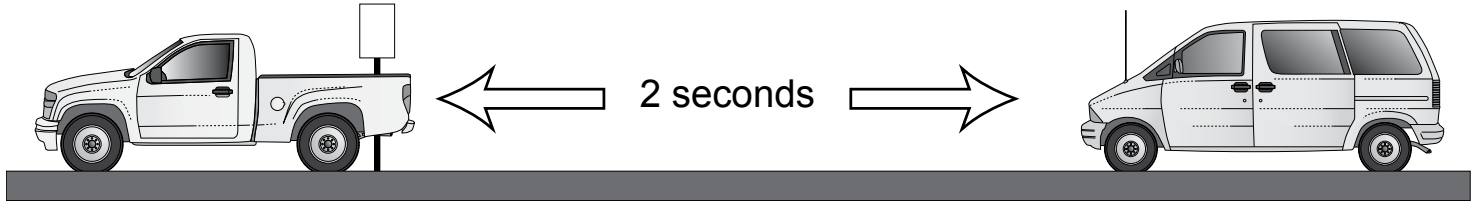

FOLLOWING DISTANCES

Most accidents where the rear end of a car is hit are caused by drivers following too closely. For cars and trucks, you should drive behind the vehicle ahead of you at least one car length for every 15km of speed (eg., if you are travelling at 30km/h, drive 2 car lengths behind the person in front of you). If the roads are slippery, double this distance. This will make sure you have enough space to stop if you need to do so.

Time Check Method

Sometimes it is hard to judge as a safe distance between your car and the one you are following. The picture above describes this method of making sure you have a safe space to stop.

To avoid rear-end collisions:

- 1 Don't be impatient. Keep calm when drivers are slow. Watch for the brake lights of the car ahead. They may not be working and you might not find this out until it is too late. Be prepared to stop suddenly.

- 2 Look ahead for problems that might develop for the driver in front of you. For example, you might see slow moving construction vehicle first.
- 3 Make sure the distance between you and the car in front of you does not become too short.
- 4 Don't try to guess what the driver in front of you will do. For example, don't be sure that the car in front of you will go straight though the intersection. Many drivers slow down at all intersections.
- 5 If the car in front of you stops, give it enough time to get moving again.
- 6 Keep your mind on the road. Don't let problems or daydreams take your attention away.

To avoid being hit from behind

- 1 Keep your brake lights clean and in working order. Flash them when you are not moving, moving slowly or getting ready to stop.
- 2 Know what's happening behind you by looking in your inside and outside rear view mirrors. Check over your back. Keep the back window clean and clear of snow and frost.

- 3 Let the driver behind you know what you will do and make your signals well ahead of turns, stops or lane changes.
- 4 Slow down over a long distance so that the driver behind will have time and space to think about what to do.
- 5 Keep pace with traffic but stay within the speed limit and conditions caused by weather, road surfaces, amount of light and other things.

PASSING

Passing in Town

You should never pass:

- 1 At an intersection on a two lane street or highway. But if the car in front is making a left turn, you may carefully pass to the right side. Make sure you don't go off the travelled part of the road or cross over the centre line. Be sure the turning car is not blocking your view of another car or pedestrian.
- 2 At a crosswalk or any place where a car has stopped to wait for a pedestrian or other vehicle.

- 3 In a school zone or playground zone even if another car is travelling at 10km/h. Don't pass on either side!
- 4 On the right side of the street except where there is a lane.
- 5 On the shoulder of a roadway, the part that is not used by cars.
- 6 On the left side of the road if there is not enough space to get back into your lane before other obstacles are reached, such as a cross walk or intersection.

Passing on Out-of-Town Roads

To pass other vehicles safely when you are on an out-of-town road, you must use extra skill, good judgement of speed and great care.

To pass a car going 50km/h in a 60km/h zone, it will take you a distance of 1/3 km going at 60km/h to finish the pass. At night, it is harder to tell the speed and distance of vehicles coming towards you passing is hard. Take your time on out-of-town roads before deciding to pass.

When traffic is heavy, you don't gain much from passing. Drivers who pass in a long line of cars might get into a head-on

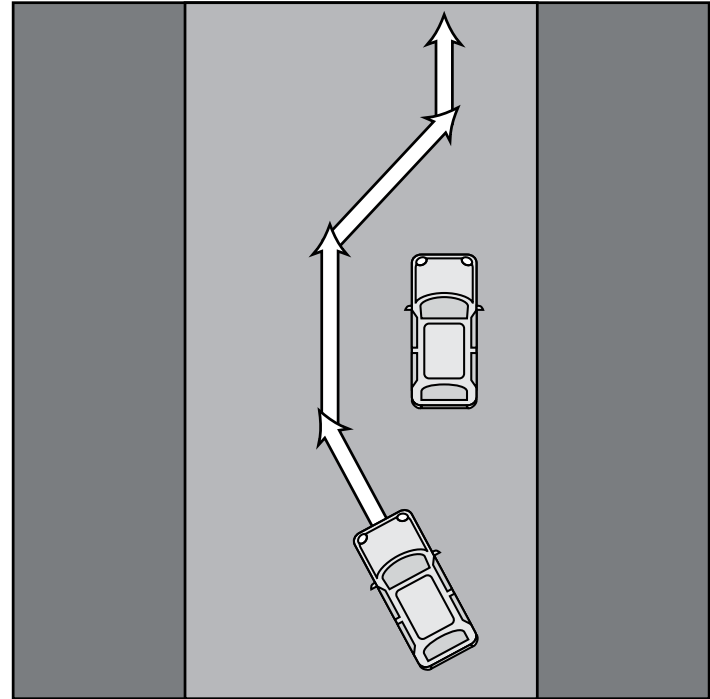

Always pass on the left.

crash or they might have to cut back into their lane fast and hit cars in their own lane.

Passing Rules

It is important to know when not to pass as well as when to pass. But when in doubt, do NOT pass. Learn the following passing rules and use them each time you think about passing.

Do's:

- 1 Decide if you really need to pass and check ahead and behind you for cars. Use both your inside and outside mirrors. Stay far enough behind the car ahead of you so that you can see in front of it.
- 2 Use your signal to show that you are going to move left. Look over your shoulder to check your mirror's blind spot. Then look ahead to make sure the road is clear enough of on-coming cars to make the pass safely.
- 3 Always pass on the left. Wait until you see the car you just passed in your rear view mirror and then check over your right shoulder. Give the right signal and then move into your lane.

- 4 If you are being passed, help the other driver out by slowing down and staying to the right of the road.

Don'ts:

- 1 Do not pull out across the centre of the road to see if it is clear to pass. You should be able to see well enough from the right side of the road.
- 2 Do not try to pass in a place where signals tell you passing is not allowed.
- 3 Do not go faster than the speed limit when passing.
- 4 Do not cut in on the vehicle you have just passed.
- 5 Do not pass when you are within 30 ms (100 ft.) of an intersection or bridge.
- 6 Do not pass going up or near the top of a hill.
- 7 Do not pass on a curve if you can't see the road for the whole distance it will take to pass
- 8 Do not pass unless the left-hand side of the road is easy to see and clear of traffic coming at you. Make sure there is enough space in the traffic in going in your direction to allow you to get back to your side of the road.

When Meeting Other Vehicles

Keep to the right of the road when meeting another vehicle moving towards you. If the road is wide enough for only one lane of traffic in each direction, try to give half the roadway to the other vehicle you meet. If this is not possible, both drivers should slow down and stop before going by each other. Help each other out in passing safely.

While there are many potholes on northern roads, drivers should stay on their side of the road as much as possible, even when the other side appears to be in better condition. Keep an eye out for on-coming traffic which may also be trying to avoid potholes.

STOPPING AND PARKING

Seeing

Before you decide to stop your car to avoid an object, you must see it. If you aren't paying attention, have poor vision or conditions make it difficult to see, you might be close to danger before you see it. Even after you have seen an object in your way, your car will keep travelling before you realize you must stop.

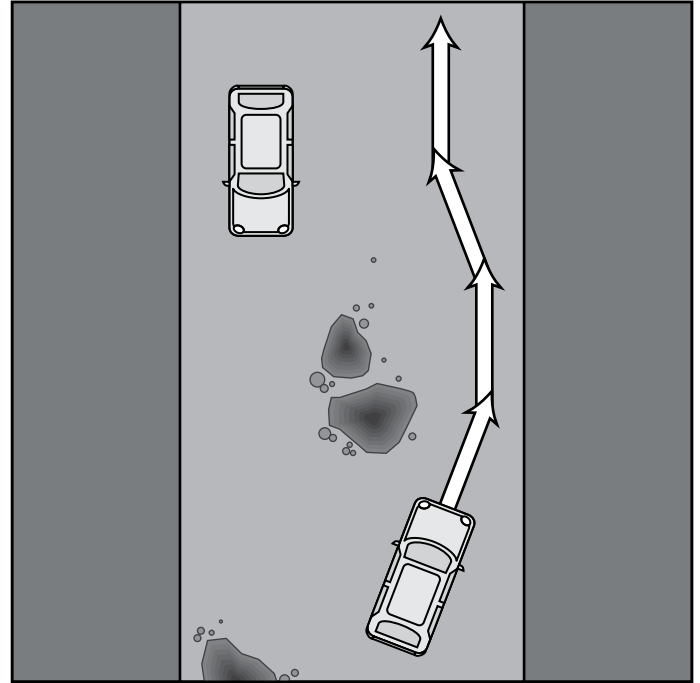

While there are many potholes on northern roads, drivers should stay on their side of the road as much as possible, even when the other side appears to be in better condition.

EMERGENCY STOPPING DISTANCES

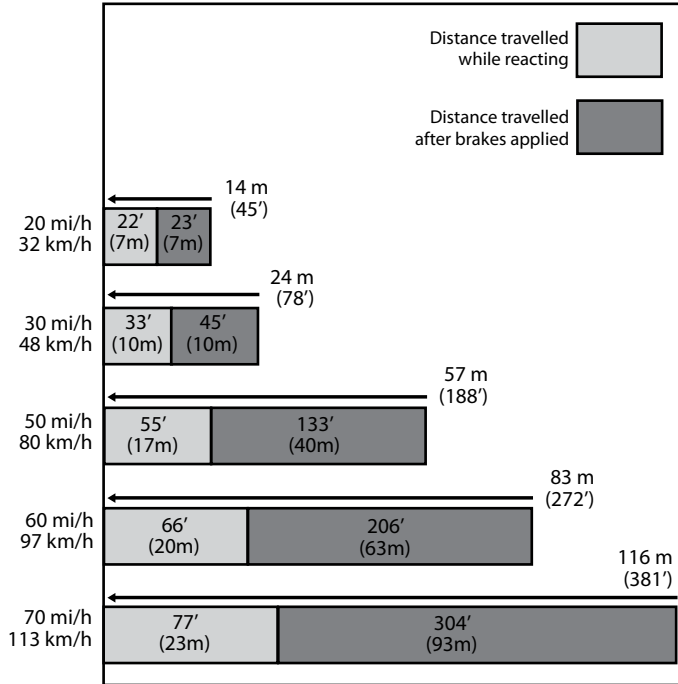

Reacting

When you know you must stop, you move your foot from the gas pedal to the brake. The distance your car travels while you do this called the “reaction distance”. Tests show how that the average driver takes one second to put his foot on the brake pedal after seeing danger. Your car will travel about 10 m (about two car lengths) during this time, if you are driving at 50 km/h, BEFORE you have even started to brake!

Braking

How far your car will travel before the brakes stop it depend on: the speed of the vehicle, the condition of the brakes and tires, the size and weight of vehicle, the type and condition of the road surface and whether you are on a level road or on a hill. Consider that a hamlet service truck, for example, cannot stop as quickly as a car and so it is dangerous to assume that the truck has the same ability to brake.

At a speed of 48 km/h, the average distance it takes to brake is 14 ms (two and a half car lengths) if the vehicle and road

conditions are at their best. Add the time it takes for a driver to see a danger and react to it by moving the foot to the brake, and the car will need 24 ms or 5 car lengths to stop.

Remember, do not use your left foot on the brake.

Stopping and Parking

You are not allowed to stop or park your vehicle in the following places:

- In a crosswalk or a 6 m (20 ft.) from it
- In front of a drive way
- Within 3 ms (10 ft.) of a fire hydrant
- Within 6 ms (20 ft.) of a driveway to a fire station, or as signs direct
- On the road side of another vehicle that is already stopped or parked
- Within 5 ms (15 ft.) of a stop sign
- Where a sign says it is an Emergency Services laneway such as a fire route access

- On a bridge
- In a way that blocks traffic or is a danger to others.
- In a parking spot, marked for disabled, unless you have a special permit.
- In places where you are allowed to stop and park, the wheels of the right side of your car must be 30cm (12 inches) from the curb or edge of a roadway.

Parallel Parking

To parallel park, you need to judge if the space between the two cars is long enough for your car. You need at least 1m (5 ft.) more than the length of your car to park easily. The steps below go with the picture above:

Step 1 Give a hand signal or right hand light signal and pump brake pedal to flash the brake light when stopping. Stop even with the car ahead about 45 cm (18 in.) away from it.

Step 2 Back slowly, turning the wheel sharply to the right until your car is at a 45 degree angle to the road side. Then straighten the wheels.

PARALLEL PARKING

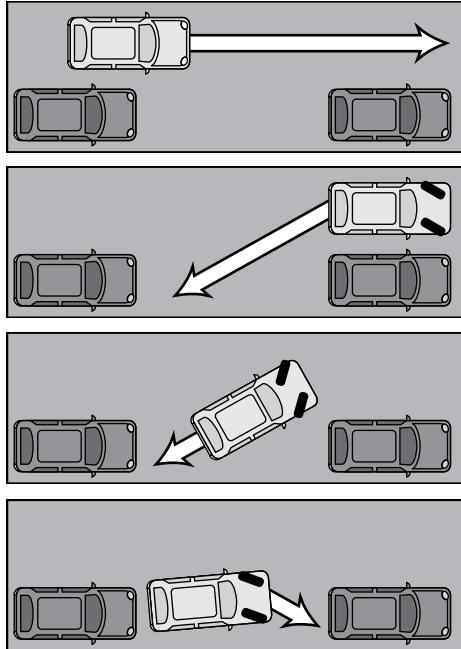

Step 3 Back slowly until you can see the left headlight of the car behind, turn wheels sharply to the left and back up slowly.

Step 4 Turn the steering wheel to the right to bring the car parallel to the road side in the centre of the parking space.

Angle Parking

This type is used in parking lots, shopping malls and in some communities on wide streets. Follow these steps:

- 1 If the parking space is on your right, use your right-hand signal and slow down.
- 2 Drive in the same direction as the roadside at least 1m (5 ft.) out from the other marked cars.
- 3 Steer sharply right when your car's front end is even with the rear of the parking space. Drive slowly into the space, until you are in the centre and midway down the space.
- 4 Straighten wheels, continue forward until your front wheels barely touch the curb or edge of the road.

Parking this way may be easy but backing out can be dangerous.

Don't rely only on your rear view mirror. Make sure it is clear behind and on both sides of you before backing out. For example, if your view is blocked by a truck parked beside you, move back VERY carefully, watching for people or vehicles that might suddenly appear.

Parking on a Hill

Place our vehicle in reverse or low gear and signal right. With manual transmission, leave it in gear and with automatic, put it in park, firmly set your brake.

Downhill Parking

To keep your car from rolling down a hill, turn your wheels to the roadside curb or edge. Your car will roll off the road rather than into traffic if something goes wrong.

ANGLE PARKING

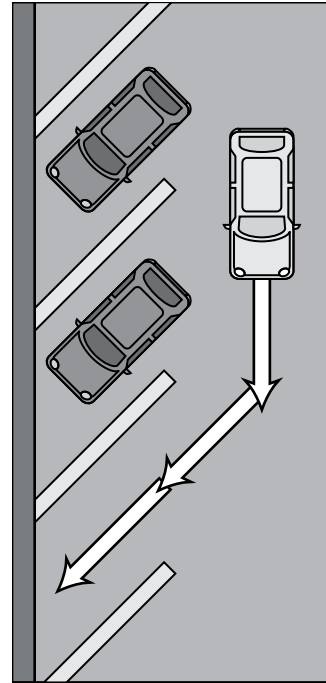

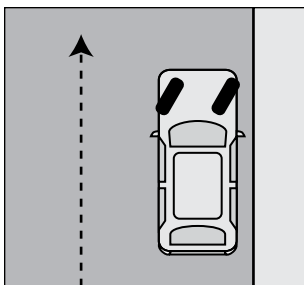

Uphill parking: Turn your wheels towards the roadside edge.

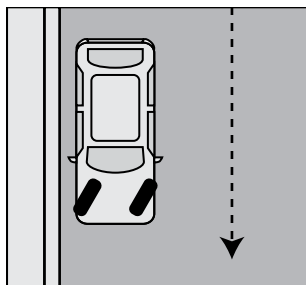

Downhill parking: To keep your car from rolling down a hill, turn your wheels to the roadside edge or curb.

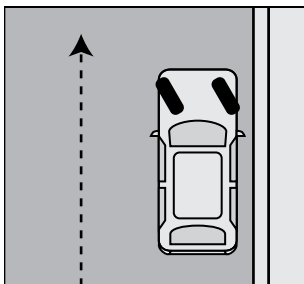

Uphill parking: If there is a curb, turn the wheels from the curb to the left.

Uphill Parking

Turn your wheels toward the roadside edge. If there is a curb, turn the wheels from the curb to the left.

General Parking Rules

- Do not park your vehicle on the part of the road used for traffic.
- Do not park in an emergency services lane such as a fire truck or emergency route. You may keep firemen from doing their job if you do.
- The law says you cannot open a door without making sure that it won't be hit by someone or something. A passing bicycle or another car may run into the door or pin you against your car.
- When you leave a parking space, always check traffic all around you. Use your turning lights or hand signals to show what you are going to do. Wait until it is safe to pull out. You do not have the right of way and you should be ready to stop and pull back to allow other vehicles to pass.

BACKING UP

Backing up your car, whether from a parking space, a driveway, a roadway or alley can be dangerous. Many injuries to pedestrians, especially children result from backing up. Obstacles may block your view, such as large vehicles parked to the side of you, snow hills, buildings and even the exhaust from your own vehicle.

Take extra care and move slowly when backing up. Start before you get into your vehicle by checking for obstacles that may block your view. Check for items that may be on the ground, such as a bicycle. Look for children, for cyclists and for dogs. Children and pets may be below the height of your rear view mirror, so be extra careful. When you get into your car, check that the roadway is clear behind you. With your foot on the brake, put the vehicle in reverse. If you are going to back up straight or to the right, look over your right shoulder. If you are backing to the left, look over your left shoulder. If you are turning as you back up, make sure not to hit anything to the sides.

If you are driving a water truck or loader, make sure another person is available to direct you as you back up and move children out of your way.



If backing to the left, look over your left shoulder



If you are going to back up straight or to the right, look over your right shoulder.

SPEEDING

You know you are travelling at a safe speed if you have complete control of your vehicle and you are able to handle any emergency that may happen.

The maximum speed limits are set by traffic engineers, police and other experts who look at accidents, records, the amount of traffic and other information. If road conditions, visibility or traffic conditions are not the best, you should slow down to less than the speed limit.

Drivers depend on others to follow the speed limit. When you drive in a 50 km/h zone, you make driving decisions with the belief that others are not going 60 or 80 km/h. Other drivers think the same way.

When you speed, other drivers and pedestrians must make sure they don't have an accident with you.

The law sets the following speed limits:

- The basic speed limit outside communities is 90 km/h or as posted;
- The basic speed limit inside communities is 50 km/h or as posted;

- The speed limit can be between 50 to 90 km/h in some speed zones;
- In “men at work” or construction zones, the speed limit is as posted, and you should drive slowly and carefully;
- In a school zone or playground zones, the speed limit is shown on a sign. Slow down and be careful to watch for children when you drive in these areas.

Safe Speed

The real question is not whether 80 or 90 or 50 or 15km/h is a safe speed. Only you can determine a safe speed by judging the conditions you find yourself in, while always keeping to the maximum speed.

Just because a stretch of road is zoned 90 km/h does not mean that it is safe to travel at that maximum every minute you are in that zone. There may be times when 20 km/h is too fast and other times when 90km/h is quite safe.

The rule for safe speed is simple. Never drive so fast that you cannot bring your vehicle to a safe stop in the clear distance ahead.

The Slow Driver

Speed is a dangerous business and so is driving too slowly. Drivers who go way below the speed everyone else is going are a danger. These drivers block those behind them, making others jump from lane to lane, or take chances on passing when they shouldn't.

Anyone driving at such low speeds that they hold up the proper movement of traffic is breaking the law. If you must travel at a slower speed, move as far to the right as you can and allow other traffic to pass or, pull off the roadway and stop to allow others to get by.

The slow driver has become more of a problem as more drivers pull trailers. It is harder to keep with the flow of traffic when you are pulling a trailer behind you. If you find you can't match the traffic flow, pull over to the side of the road and let others pass by.

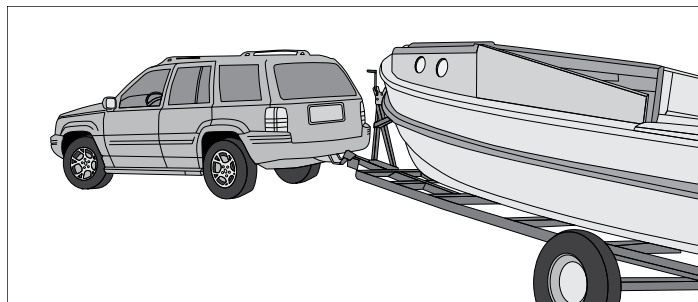

When towing a trailer, double your following distance and give yourself twice as much time to stop, turn and pass.

Towing a Trailer

Before you pull a trailer, make sure your car can handle it. Do a practice drive before you take it on a trip. Get the feel of the extra weight, test your brakes and practice backing up.

Trailer towing calls for very careful driving. Double your following distance and give yourself twice as much time to stop, turn and pass. Give other drivers more warning. Brake slowly when towing.

OTHER THINGS TO WATCH FOR

Animals

You may come upon animals on out-of-town roads and occasionally within town both on roads and in parking areas. Dogs are a special problem for Nunavut drivers. Keep a look out for dogs around your car as you park, back up or drive through town.

Always be alert for animals on the road and ready to react. Look well ahead. At night use your high beams where possible. If you see an animal, brake or slow down without causing a problem to vehicles behind you. If there is no traffic and no danger of hitting another object, drive around the animal but always keeping control of your vehicle.

Riders in the Back of a Pick-up

You may carry passengers in the box of your pick up if you are travelling at a slow speed, 30 km/h or less. Drive carefully, check for bumps and potholes that may be a danger to your passengers. While carrying passengers in the back of your pick up truck is allowed, it is considered to be an unsafe practice.

Firearms

The rule is simple, never carry a loaded firearm in your vehicle. If you have a firearm, make sure it is locked.

HAZARDOUS DRIVING CONDITIONS

“It’s the law to drive with headlights on all times.

GRAVEL

Driving on gravel is not the same as driving on pavement and gravel roads are the norm in Nunavut. If you know how to react on gravel, your trip will be safe and pleasant. The main differences between gravel and paved roads are:

- 1 Dust
- 2 Flying
- 3 Loose gravel
- 4 Poor traction

DUST

Any vehicle moving at a good speed will leave a dust cloud. The dust cloud from a tractor trailer may be 0.5km long or more. There might be another vehicle hidden in that cloud. It might be travelling in the opposite direction. Maybe the tractor driver can’t see because of the dust and he is driving on the wrong side of the road. There might be a parked vehicle or vehicle following

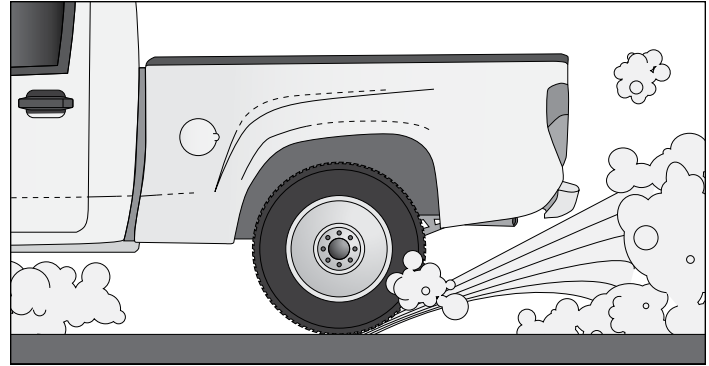

Don't try to pass any vehicle creating a heavy dust cloud.

the tractor in the dust cloud. Or there might be a section of loose gravel or a pothole or two that you can't see.

If you try to catch up to and pass a vehicle making a dust cloud, you might not see one of the dangers until it is too late. Don't try to pass any vehicle creating a heavy dust cloud.

Stay back out of the dust cloud until the driver ahead stops or until you come to a stretch of road where the surface has been

treated or is made of a different material and there is little or no dust. Then pass without delay.

Never stop quickly in dust except in an emergency. If you have a flat tire or engine trouble while in dust, slowly bring your vehicle to a stop. This will give the dust a chance to clear and any vehicle behind you will have time to see and go around you.

When you meet a vehicle throwing up a heavy dust cloud:

- a** turn on your headlights before you drive into it;
- b** get well over to your side of the road and slow down;
- c** picture the position of on-coming vehicle and the edge of the road ahead and hold steady;
- d** be ready for action in case some careless driver behind the on-coming vehicle decides to try and pass.
- e** close your windows, turn off the fan of your heater and open the forward vents located in the sidewall of the drivers and front passenger's foot area. This will keep dust from entering your car. The pressure will build up and keep the dust from coming in the vents, or at least keep it down.

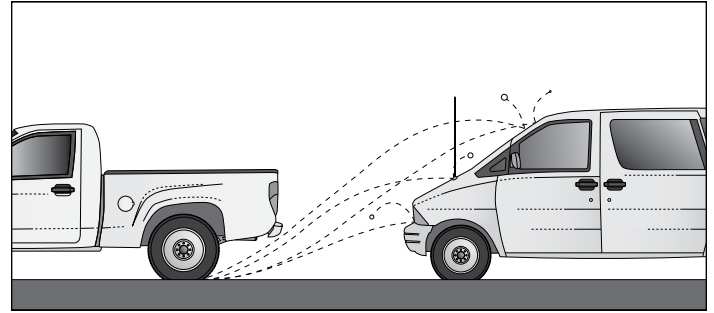

At high speeds, the tires of a vehicle shoot rocks and stones out, high and wide.

FLYING ROCKS AND STONES

At high speeds, the tires of a vehicle shoot rocks and stones out, high and wide. They don't travel straight back or stay low.

A car trying to pass another on a gravel road will be forcefully hit with stones. Stones can chip paint, dent grills, fenders and body, smash headlights, pit, chip crack or start windshields. A few things can help to prevent this damage.

To save headlights, cover them with plexi-glass covers, this will make the stones bounce off. Replace the covers because when they are scratched the scratches cut down the light.

Be sure the driver ahead knows you want to pass. Put your lights on and flick them from high beam to low beam. The driver ahead should move as far as it is safe to the right of the road and slow down to less than 80 km/h. This will make less dust, make fewer stones fly and help you to pass more quickly.

Installing fender mud-guards behind wheels will cut down on the stones you throw. Protect your gas tanks from stones making holes in it by using rubberized fabric to hang in front of it.

LOOSE GRAVEL

Many accidents are caused by vehicles hitting a stretch of loose gravel, or getting stuck in a ridge of gravel made by a grader, or getting too close to the edge of the road.

The first rule is do not travel too fast in loose gravel.

The second rule is, where you feel gravel pulling at your wheels, slow down but don't use the brake.

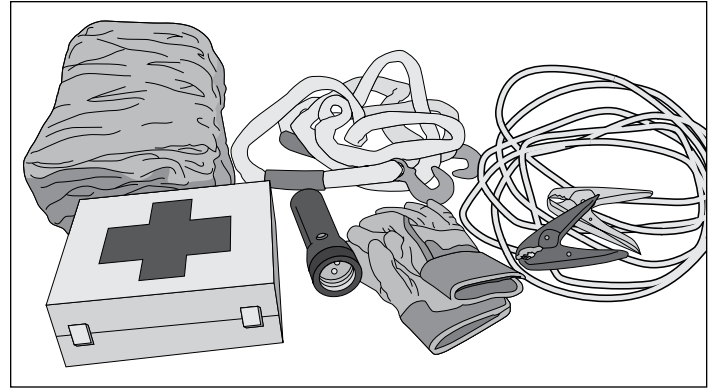

Making sure your vehicle is ready for winter will help stop problems before they start.

The third rule is do not over-steer. Don't jerk the wheel over to get to a harder surface. Slow down, hold steady.

Vehicles such as light pick-up trucks that are not loaded have light rear ends. On rough gravel roads the back end will float and dance over the road and be hard to control. Use the same three rules above. Slow down but don't brake, don't over-correct your steering, hold steady and the vehicle will return to its proper course.

ICE, SLEET AND SNOW CONDITIONS

Winter Driving

Nunavut winters are often hard and can be dangerous. Making sure your vehicle is ready for winter will help stop problems before they start. Get a mechanical tune-up and use snow tires, or keep a set of tire chains in your car. Equipment to clear your windows of snow, frost and moisture should be kept in your car.

When your car is not on the road, there are important things to remember during the winter. Never leave your engine running in a closed garage because of the danger from exhaust fumes. Deadly carbon monoxide gas from the exhaust system is a winter danger. The gas has no smell and a very small amount can cause death.

Have your muffler and exhaust system checked for leaks. If you park with the engine running, make sure it is in the open air. At the first sign of dizziness, feeling sick to your stomach, ringing ears and sleepiness, stop the motor and get into the fresh air.

You should get the feel of the road when you start out by testing your steering control and brakes. Never spin your tires. Start

slowing down before you come to an intersection at a distance three times the usual distance you are used to. Leave a longer distance between yourself and the vehicle in front of you.

If your vehicle is a rear wheel drive, add weight in the trunk or back end with bags of salt or dry sand. Do not use cement blocks, frozen sand, logs or iron for weight.

Place the weight over rear axle. Do not use too much weight or place it too far back as this could lift your front wheels and cause you to lose control of steering.

In deep snow, keep the wheels straight and avoid sharp turns. Try to keep a steady speed to carry you through the deep snow.

Be careful when passing. Don't step on the gas pedal too quickly while passing because you can skid or spin.

Travelling during a Nunavut blizzard is not a good idea. Pay attention to storm and weather warnings. If you cannot postpone your travel, start the trip with a full tank of gasoline. Arrange for someone to get a phone call to tell them of your

arrival and have a back-up plan if the call is not received. Carry traction ramps for the rear wheels in case you get stuck.

Have: antifreeze in the radiator, good windshield wipers, and airtight muffler and exhaust system, dependable battery, fan and other belts that are not worn or cracked, tire chains and shovel.

Watch out for stalled or skidding cars. Be on the lookout for shady spots where ice may be slick. Listen for weather and road condition reports.

Icy Roads

On wet or icy roads, you can't stop your car as well as you do on dry roads. When slowing or stopping, pump the brakes until you come to a full stop or the speed you want.

Do not press the brakes hard as the wheels will lock and start you skidding. On slippery roads, do the following:

- 1 drive at a slower speed;
- 2 keep farther back from the vehicle in front;
- 3 use tire chains if you need to;

- 4 don't make sudden moves eg. Suddenly braking, steering, shifting to a slower gear.

Starting on Ice

Start in first or second gear. This will help stop skids and spinning of wheels. Tires can grip a slippery surface better if the wheels are turning slowly.

Black Ice

When driving on bare pavement in the winter, watch for patches of clear ice which are hard to see because of the dark colour of the road underneath.

Fog

The best rule when it is foggy is not to drive, but if you must, you should;

- greatly reduce your driving speed
- turn your headlights on

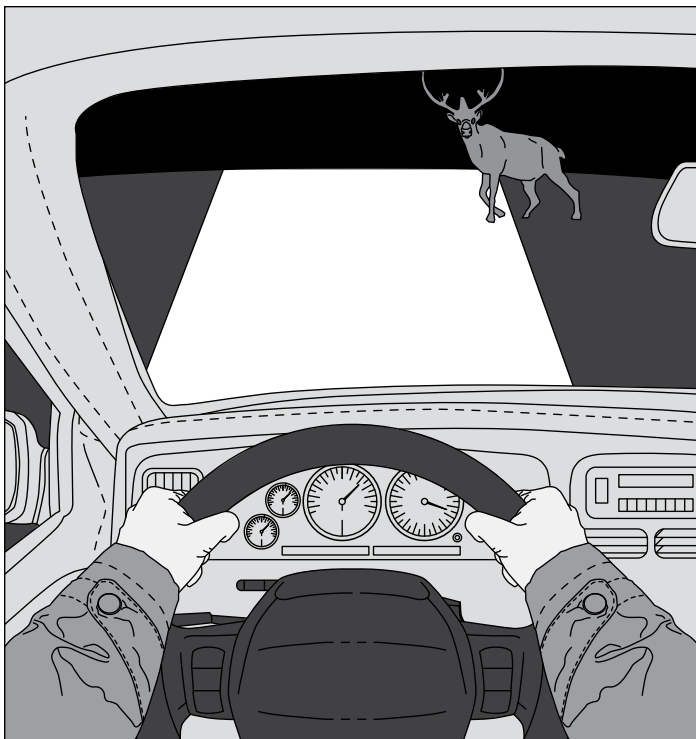

At night you can't see as far and as much as you do in daylight.

- slow down even more if you see headlights or taillights. These might be on a vehicle driving in the middle of the road or moving very slowly.
- be prepared for emergency stops. If the fog becomes so thick you can hardly see, carefully pull over to the side of the road and stop. Wait until the fog lifts and you can see better.
- Dim your headlights to cut down on the glare from the fog. Don't use high beams.

NIGHT DRIVING

Although we drive less at night than in the day, the number of serious accidents happening after dark is three times greater than for a daytime. Some reasons for this are:

At night you can't see as far and as much as you do in the daylight. Objects appear different and may blend in with the dark background.

Too many drivers try to keep up their daytime speed at night. You should slow down. Never drive so fast that you can't stop

within the distance your headlights are lighting the road ahead. Otherwise you are over-driving your headlights.

At 80km/h, you need 57 m to stop your vehicle under the very best conditions. Under normal conditions, headlights on high beam light the roadway about 30 m.

By law, you must use your headlights on a highway at night, or at any other time when there is not enough light.

Glare

At night, glaring headlights of oncoming cars or the reflection of lights in your rear view mirror can make it hard for you to see. Often, you can't see at all for a short time.

The glare causes the pupil of your eye to close and it takes time for the pupils to get used to the dark again. During this time, you are driving blind. The amount of time needed to get back to normal is not the same time for everyone, but the problem is worse for older drivers and those in poor health.

You can reduce the effects of glare by looking away from the light and looking to the edge of the road. To cut glare from the rear, adjust your mirror or use a day/night mirror.

Slow down until your eyesight has recovered from the glare. The most dangerous time to drive is at dusk and dawn, because of the twilight. Extra care should be taken at this time of day because of the glare.

Direct sun also requires the use of sunglasses or a visor. Drivers should slow down and proceed with caution if unable to see because of direct sunlight.

Speed

When it is hard to see, driving at a high speed does not give you time to stop to avoid hitting a pedestrian, an animal, road hazards or another vehicle.

Poor road conditions, rain, snow, fog, dust or smoke should make you slow down to a speed that will let you stop within the distance that you can see. If you find these conditions, you should slow down to below the speed limit on signs.

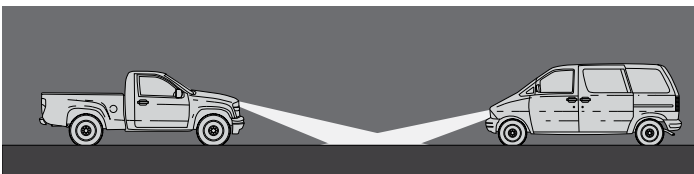

Dim your headlights when you come within 300 m (1000 ft.) of an oncoming vehicle

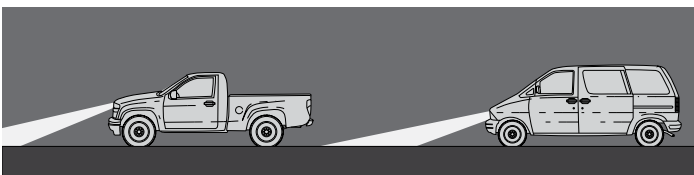
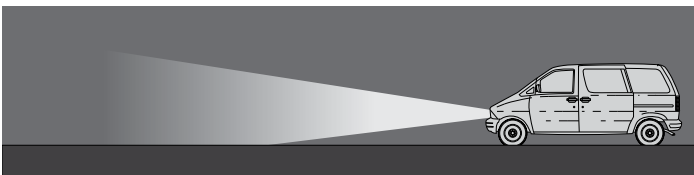

Dim your headlights when following another vehicle.

Additional Pointers

Some things you can do to make night driving easier:

- 1** Have your headlights checked twice a year to see that they are aimed properly. If you drive a great deal, or on rough roads, you may need to have them checked more often. Low beams should show objects at least 30 m (100 ft.) away, but should be aimed below eye level of an oncoming driver. If not at proper height, it could be harder for you to see and it could blind other drivers.
- 2** Dim your headlights when you come within 300m (1000 ft.) of an oncoming vehicle. Don't wait for the other driver to dim his lights first. Don't be tempted to "pay him back". A driver blinded by your high beams might sideswipe your car.
- 3** Dim your headlights when following another vehicle. The law says you must do this within 60 m (200 ft.) of the vehicle ahead. The glare caused by your headlights shining in the other driver's rear view mirror can make it harder for him/her to see and cause an accident.

- 4 Clean your headlights regularly. Dirty headlights reduce the amount of light, making it harder to see.
- 5 Bright lights inside the car can make it hard to see outside. Keep inside lights off so that your eyes will stay used to the dark
- 6 Slow down when meeting another vehicle or when coming near a curve. You may not be able to see something in the road because of the glare. Someone may have stopped without their lights or emergency flashers on.
- 7 Watch out for pedestrians and vehicles on the sides of the road. Walkers may be difficult to see if they are wearing dark clothing. Since roads are not paved, pedestrians often walk on the side of the road because walking conditions are better there.
- 8 Watch out for children at play, especially children who might be sliding on the road.
- 9 Never stop on the part of the road you drive one. If you must stop, pull off onto the shoulder and use emergency lights, flares, red reflectors or red triangles.

10 Watch for road signs, they're harder to see and read at night.

11 Keep both inside and outside of the windshield clean.

DROWSINESS AND FATIGUE

Closing your eyes for just a second can cause a fatal accident. If you feel drowsy or half asleep, it can be like being drugged. The boring effect of driving over a long distance can make you like this. Get lots of rest before starting out. Some ways to be less tired:

- 1 Stop as often as you need, for example, every two hours.
- 2 Get out of your car and walk around
- 3 Change drivers for a while.
- 4 Get a cup of coffee.
- 5 Get passengers to talk with you; chew gum or eat fruit candies; listen to radio or tapes or sing aloud to yourself.
- 6 Move your eyes around and look to the distance, then focus

on closer objects, and move your eyes from side to side.
Check your mirrors

- 7 Open the window to let fresh air and keep the car cool. Every once in a while change car speed slightly and change your body position.
- 8 If all else fails, stop well off the road and have a sleep. But use your four way flashers to keep from being hit

CURVES AND HILLS

Slow down before you enter a curve, not while you're in it. You can speed up gradually when you are in the curve. Be careful of other cars going too fast and going outside their lanes and into yours.

Sharp curves often have signs telling you the highest speed you should use. If you find yourself going into a curve too quickly, don't jam on the brakes. Brake gently and then speed up.

On hills, go slow as you come to the top. As you go over the top and down, you will need more distance to brake. If the downhill is very steep, shift into lower gear before starting down because this will help save your brakes.

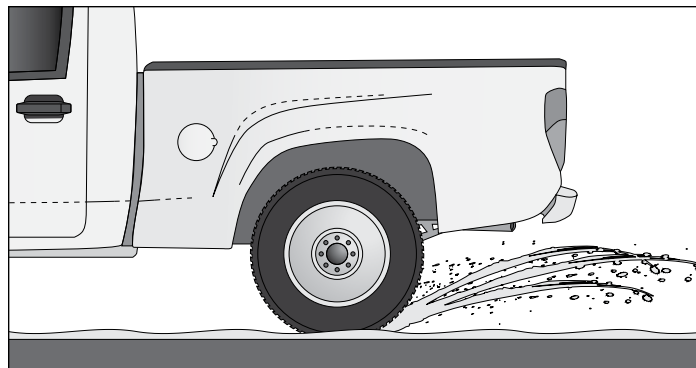

If hydroplaning, the best thing to do is let your foot off the gas and gradually slow down.

Never coast down a hill in neutral or with our foot on the clutch because this will mean the whole job of stopping you is on the brakes. Coasting in neutral can also hurt the engine and transmission.

HYDROPLANING

On wet roads, your car's tires start to ride on a film of water as you go faster. If a car is hydroplaning, the tires no longer touch the road and you won't be able to stop by using the brakes. If

the tires are riding on a film of water, the wind could blow the car off the road or cause it to skid.

If you find yourself hydroplaning, the best thing to do is let your foot off the gas and gradually slow down. Don't slam on the brakes. If you are skidding off the road, try to control the car and wait to slow enough to gain control of the car again.

RAIN

Rain can mix dirt and grease on the road and make it slippery. When it starts to rain, slow down. When muddy roads dry, they can become very bumpy and they look like a washboard. Drive slowly and carefully.

SNOWPLOWS AND MAINTENANCE MACHINERY

Snowplows in Nunavut use flashing orange lights to warn other traffic. When you meet a snowplow on the road, you must give it right-of-way (let it go first). Pass a snowplow carefully because it is hard to see around the plow.

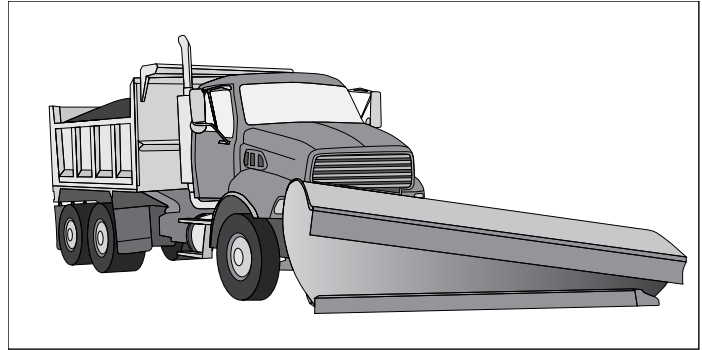

Snowplows in Nunavut use flashing orange lights to warn other traffic.

Road maintenance equipment, including trucks, have the right-of-way when they are flying a red flag or flashing amber light and they are involved in roadwork.

Sometimes this equipment might be on the wrong side of the road. During the construction season, warning signs will mark the parts of the road being maintained. Drivers should slow down and follow the directions of the flagpersons.

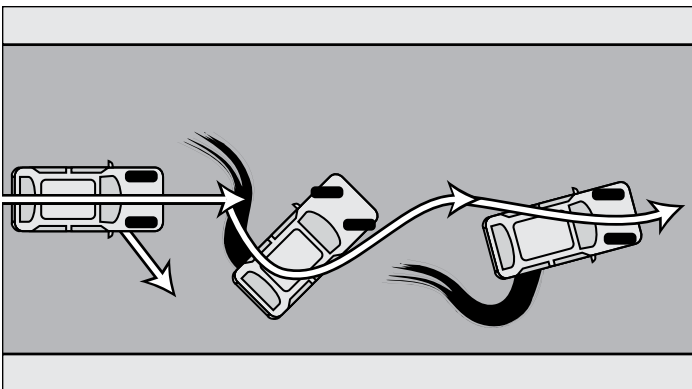

Steer in the same direction that the rear of the car is skidding.

DRIVING EMERGENCIES BLOW-OUT

A tire blow-out can cause you to lose control of your vehicle. Depending on which tire blows, the car will act differently. If a front tire blows, steering will be hard. If a back tire blows, the car will fishtail from side to side.

If you have a blow-out, don't be alarmed. Take your foot off the gas pedal to slow down and steer the vehicle firmly in the direction you want to go. Bring the vehicle to a stop off the road change the tire.

Regularly check tires for cuts or bulges. When driving a bulge may cause a thumping noise which will warn you, or your car may pull sideways from loss air in the tire can be the cause of blowouts.

SKIDDING

Skidding happens when your tires do not grip the road. Your car will lose traction and start to slide. It can happen on dry and wet roads.

Skidding is also caused by sand, gravel, bumps, mud, oil, slicks, frost, wet steel gratings and wet planks. When you skid, your brakes cannot save you. Instead of braking, you should:

- 1 Steer in the same direction that the rear of the car is skidding.
- 2 Take your foot off the gas.
- 3 Pump the brake when the vehicle is under control and don't brake hard.
- 4 Once the car starts to straighten out again, the front wheels should be made straight to stop skidding in the other direction.
- 5 To avoid skidding, slow down as you see a danger spot and do not speed up, brake or change directions quickly.

WET BRAKES

Your brakes may not work when you go through a large puddle of water. To make sure they are working:

Test the brakes after going through deep water. Do this as soon as you can because the brakes may pull the one side or may not work at all.

You can dry the brakes by driving slowly for a while and pressing the brakes lightly.

DISABLED VEHICLE

If your car stalls or you are in an accident, move it clear of other traffic. If you can, try to park all four wheels off the travelled part of the road.

If you have standard shift, use the starter and low gear to pull your car to the shoulder. Then you should:

- Turn on your parking lights or emergency flashers.
- Warn other traffic that you are stopped by putting a reflector sign or flare 60 m (200 ft.) in front and behind.
- If you cannot move off the road, raise the hood or tie a cloth to the door handle to warn other drivers.

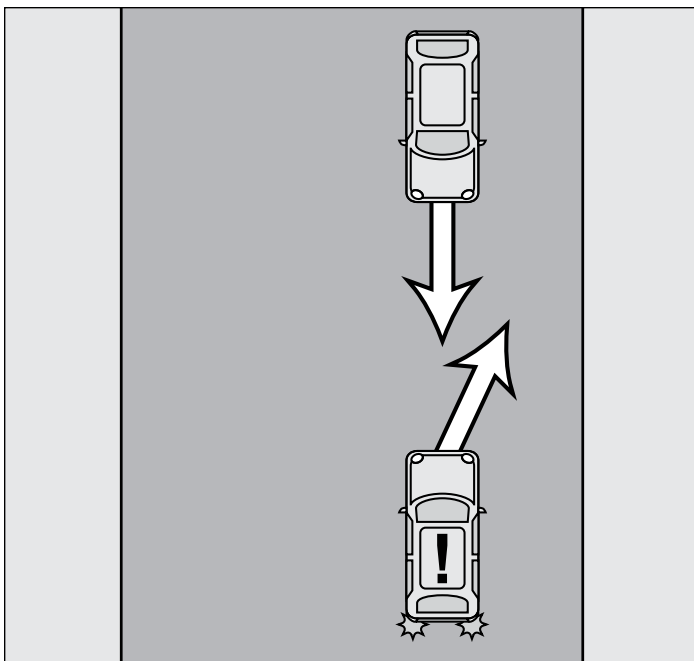

Direct Collision Course

Take to the ditch, it is better to hit the ditch than hit another car head-on.

DIRECT COLLISION COURSE

What do you do when a vehicle is in your lane on a collision course?

- 1** Brake hard. If you can slow the speed before the collision, the impact won't be so bad.
- 2** Head for the shoulder on the right-hand side of the road and lean on the horn. The other driver might suddenly realize the danger and steer back to his side of the road.
- 3** Never swerve to the left to avoid an accident because you might get in the path of other traffic.
- 4** Take to the ditch. It is better to hit the ditch than hit another car head-on.
- 5** To make the force of the crash less, head for something that can take some of the impact (eg. bushes or now bank).
- 6** It is generally better to hit something with a glancing blow (sideswipe) than to hit head on.
- 7** Be alert in case you have to make a life or death decision.

Accelerator Pedal Jams

If your gas pedal sticks, shift into neutral (depress the clutch) and bring the vehicle to a stop. Turn off the engine and call for help.

DRUGS AND ALCOHOL

Driving under the influence of alcohol is one of the most irresponsible offences you can commit. Alcohol is by far the greatest danger to a driver and other drivers, pedestrians and vehicles on the road. Even one drink can reduce your ability to concentrate, to watch for and react to things that happen

suddenly when you are driving. With more alcohol in your blood, judging distances will be hard and your vision blurred.

It may seem to you that alcohol makes you more relaxed and confident and it is this false sense of security that could add

BLOOD ALCOHOL CHART

		Number of alcoholic beverages									
		1	2	3	4	5	6	7	8	9	10
Weight in Kilos (in pounds)	40 (80)	.049	.097	.146	.194	.243	.291	.340	.388	.437	.485
	50 (110)	.040	.079	.119	.159	.198	.238	.277	.317	.356	.396
	60 (130)	.033	.066	.099	.132	.166	.199	.232	.265	.298	.331
	70 (150)	.028	.056	.084	.112	.140	.168	.196	.224	.252	.280
	80 (170)	.025	.050	.075	.100	.125	.149	.174	.199	.224	.249
	90 (190)	.022	.044	.065	.087	.109	.131	.153	.174	.196	.218
	100 (220)	.019	.039	.058	.078	.097	.116	.136	.155	.175	.194
	110 (240)	.018	.036	.053	.071	.089	.107	.125	.142	.160	.178
	120 (265)	.017	.034	.051	.068	.086	.103	.120	.137	.154	.171

you to the fatal statistics. You don't have to look or feel drunk before alcohol affects you.

The legal limit for drunk driving is when your blood alcohol level does not exceed 0.08%. The following chart gives you an idea of how the number of drinks you have might show up in your blood level. Remember though, those numbers vary from person to person. And a police officer may charge you no matter what your level is, if your ability to drive safely is in any way impaired.

Drugs given by your doctor, such as sleeping aids or anti-depressants can and will affect how you drive, if you take enough. When these drugs are combined with small amounts of alcohol, the effects of both drug and the alcohol are even more serious. It could be more harmful.

It appears that illegal drugs act on drivers in the same way that alcohol does. Normal thought processes may be dulled and hand eye coordination is slowed down. Braking time can be slowed down between 20% and 60%. Some drugs may cause irritability, feeling of being persecuted (maltreated) and even hallucinations.

MOTORCYCLES

A motorcycle is a vehicle that has two or three wheels, is designed to be used on roads and does not have a cab for the driver.

SPECIAL PROVISIONS

- Must be equipped with a rear view mirror.
- Must be equipped with at least one headlight which can light the road at least 110 ms (350 ft.)
- At least one red taillight is visible to the rear in day time for 30 ms (100 ft.) and is lit by using both hand and foot brakes.
- Should have two brakes.
- Must have a horn.
- Must be equipped with a muffler.
- All riders must wear helmets.
- Passengers are not allowed unless it is equipped for two persons.

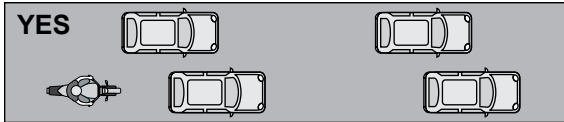
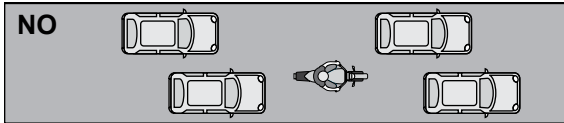

*Follow others at a safe distance, in relation to your speed.
Always leave yourself a way out.*

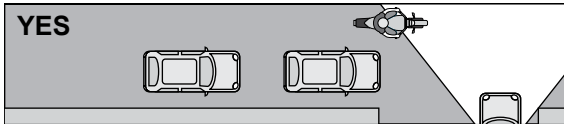
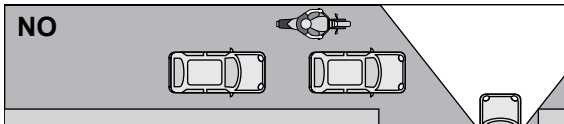

When in traffic, travel to the left of your lane. That way you can be seen by the driver in front and you have a better view of the road ahead.

SPECIAL RULES

Motorcycle drivers must not only obey the general rules but they have special rules that apply to motorcycles.

- 1 Motorcycles must not ride side by side in traffic lanes.
- 2 When stopping, gradually apply rear wheel brake and follow up with the front wheel brake.
- 3 Moped operators need a class 5 driver's license. All others, including motor scooters and mini bikes require a class 6 driver's license.
- 4 A person may learn to operate a motorcycle if they hold a Class 7, 6, 5, 4, 3, 2 or 1 driver's license and have a class 6 license holder with them on the bike, or following in or on another vehicle by the class 6 holder and kept in view all the time.
- 5 A learner is not allowed to drive his/her motorcycle when it is dark or in speed zones of 70 km/h or greater.

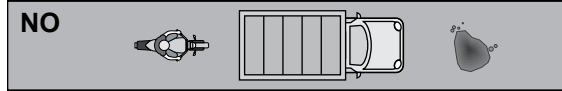

Motorcycle driver cannot see pothole.

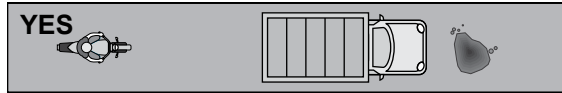

*Follow others at a safe distance, in relation to your speed.
Always leave yourself a way out.*

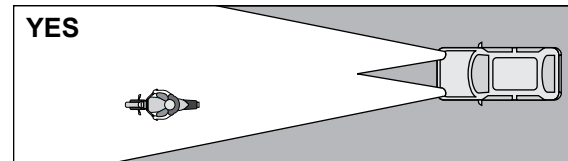
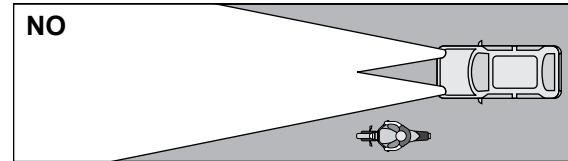

*When in traffic, travel to the left of the centre of your lane.
That way you can be seen by the driver in front and you have a better view of the road ahead.*

MOTORCYCLE DRIVING TIPS

- Before starting out check for oil, water or gravel under your bike.
- When in traffic, travel to the left of the centre of your lane. That way you can be seen by the driver in front and you have a better view of the road ahead. Avoid the oily strip, which is often in the centre lane.
- When being passed by another vehicle, maintain your speed and lane position.
- Never change lanes or move from one side of the lane to the other without first looking over your shoulder to see if there is room.
- Follow other at a safe distance, in relation to your speed. Always leave yourself a way out.
- Don't think that other drivers will give you way to you. They may not see you and suddenly turn in front of you. Be extra careful at intersections.
- Be alert to changing conditions. Keep looking at least a block ahead for unexpected hazards.
- Never pass between traffic at the road edge part of the lane and edge of the road. A car might suddenly turn or pull aside to park.
- Increase your safety by being seen. Wear light or bright coloured clothing.
- When braking, use both front and rear brakes together. The front is more powerful, so apply the rear brake and ease the front brake.
- Pass stopped cars carefully, a door might open.
- Inspect your bike often, especially clutch and brake cables.
- For a long stop in traffic and at stop signs, place your bike in neutral.
- All turns should be made with the motorcycle positioned in such a way as not to let any other vehicles share the traffic lane with the motorcycle, use the center of the lane.
- Special care and attention is essential at all times when driving a motorcycle. Your chances of personal injury, if you are in an accident, are much greater than if you were driving a car or truck.



Give your name, address, licence number and ownership details to the other driver and to anyone who might be hurt.

There are certain things the law says you MUST do if an accident happens:

- 1** Stop and give all the help that is reasonable.
- 2** Stay at the scene of the accident until the legal things have been looked after or until a police officer says it's okay to leave.
- 3** Give your name, address, license number and ownership details to the other driver and to anyone that might be hurt.
- 4** If anyone has been hurt or killed, or if the damage is more than \$1,000.00, you must report the accident to the nearest RCMP office.

It is also a good idea to do the following:

- 1** Get names and addresses of all witnesses.
- 2** Exchange insurance details with the other driver.
- 3** Do not discuss who might be at fault.
- 4** Take notice of the details such as time, location, weather conditions and draw a sketch of the scene of the accident.
- 5** Notify your insurance company as soon as possible.

If you are the first to arrive at the scene of an accident:

- 1** Pull off the road and stop.
- 2** Put on emergency four-way flashers to warn other drivers.
- 3** Offer all help that is reasonable.
- 4** Notify the police and be accurate as you can, especially about the condition of anyone who is hurt and the location of the accident.

REGULAR SIGNS

Here are some examples of commonly seen regulatory signs:



Come to a STOP and do not proceed until absolutely safe do so.



Yield the right of way to traffic not facing this sign and to all pedestrians within the intersection or crosswalk.

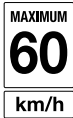

Maximum speed limit is allowed under ideal conditions



Advance warning of a lower maximum speed zone ahead.



No U-turn permitted. You must not turn your vehicle around in the roadway to travel in the opposite direction.



Do Not Enter – You must not enter this road when confronted by this sign.

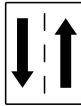

Two-Way traffic. This sign means that you are no longer on a one-way road and that you must drive in the right hand lane.

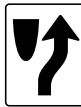

Keep right – This sign is placed on traffic islands and road obstructions and requires you to pass to the right.



Truck route – Trucks may use a road where sign is posted.



No trucks permitted- No heavy trucks allowed on a road anywhere this sign is posted.



School Crosswalk Sign – Reduce speed and be prepared to stop. Never attempt to overtake and pass a moving or stopped vehicle at these crosswalks.



Passing permitted if the way is clear.



No passing permitted.



These signs are used to indicate roads upon which traffic is allowed in one direction only.



No turns permitted.



No left turns permitted.



Turn right only.



Turn left only.



No right turns permitted



Turn right or left only.

Overhead Designation Signs

These signs are mounted above the roadway on the approach to an intersection, and each sign is centered over the lane it controls. When in a lane controlled by one of these signs, the motorist must only make the manoeuvre indicated on the signs, the motorist must only make the manoeuvre indicated on the sign.



Lane No.1



Lane No.2



Lane No.3

A driver in lane No.1 must turn left.

Lane No. 2 is optional, either left or straight ahead. Lane No. 3 must turn right.



This lane:
right
or thru.



This lane:
right or left.



This lane:
all movements.



This lane:
thru only.



Do not stop to wait.



This sign indicates where you may park.



Motorized snow vehicles are prohibited on a road where this sign is posted.



No left turns permitted.



No right turns permitted.

Warning Signs

Here are some examples of commonly seen warning signs.



Sharp right turn ahead.



Narrow structure ahead.



Sharp right curve, maximum comfortable speed – 40km/h.



Pavement narrows ahead.



Right curve ahead.



Divided road begins.



Reverse curve ahead.



Divided road ends.



Winding road ahead, use extra caution, as passing is restricted.



Hidden intersection ahead; watch for vehicles approaching from both directions.



Two lanes ahead merge ahead.



T-intersection; use caution



Stop sign ahead.



Traffic light ahead.



Bump or rough road ahead.



Steep hill ahead.



Dead end; exit right or left.



Road slippery when wet; caution.



Playground or playground cross-walk ahead.



Pedestrian activity ahead.



Chevrons warns of alignment changes on curves or sharp turns.



Section of road ahead regularly crossed by caribou or other large animals.



Road ahead narrows to one lane; right lane ends.



Pavement ends-continuation has gravel surface.



Possibility of fallen rock or landslides obstructing roadway.



Two-way traffic ahead.



Truck entrance.



Warns that road shoulders immediately beside the travelled portions are soft and may be dangerous.

Hazardous markers

Obstacles on roadway or shoulder.



Pass on either side of obstacle.



Pass on right of obstacle.



Pass on left of obstacle.

Construction and Maintenance Signs

These signs are used for road construction and maintenance projects to warn you of hazards ahead by cautioning you to slow down to a safe speed to meet any situation that may be hazardous to you or the workmen.



Flagman ahead.



Warns of barricade across a road which closes a road or diverts traffic.



Diversion

Warns the motorist of temporary change in roadway alignment.



Men working ahead.

Slow Moving Vehicle Sign



This sign warns of a slow moving vehicle ahead. Slow moving vehicle signs may be found attached to the rear of a vehicle which is travelling substantially slower than the posted speed.

Pedestrian-School Advance Sign



This sign warns that you are approaching a school zone. Slow down, drive with extra caution, and watch for children. When this sign has a “Maximum Speed” or “km/h During School Days” tab mounted underneath, it means the speed is to be observed as indicated.

Services & Information Signs



Aeroplane points direction to airport.



Hospital



Boat launch



Café



Trailer facilities



Service stations



Travel information



Tenting



Picnic facilities



Hotel or motel



Police



Roadside rest area